

Connemara National Park

Wayfinding Layout

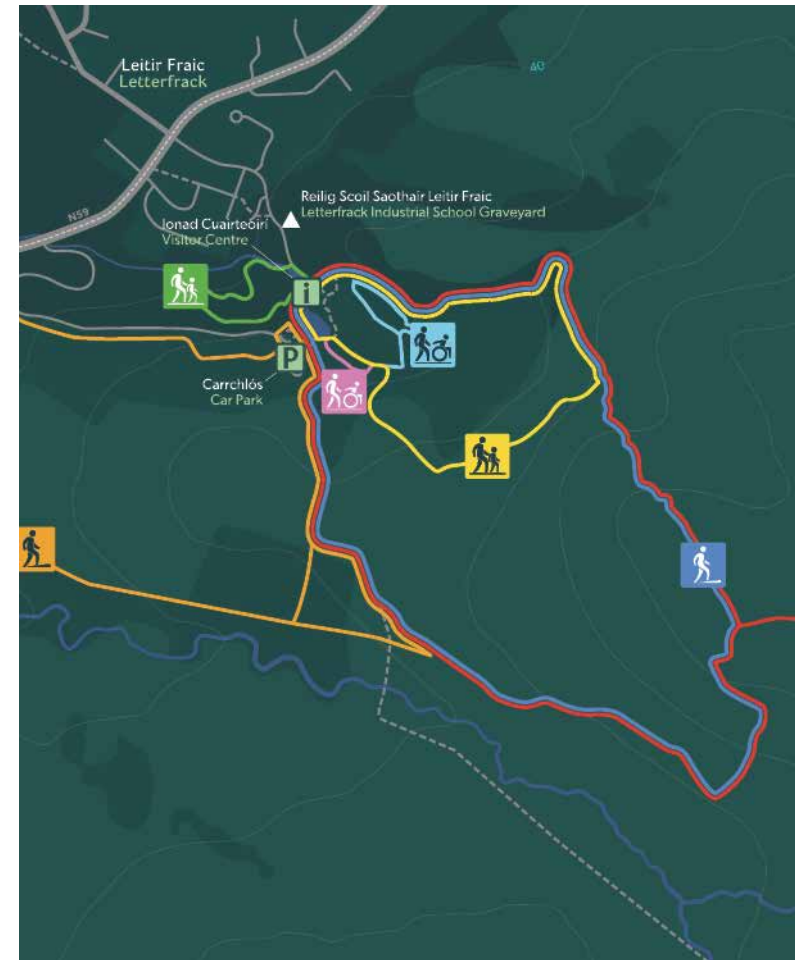

Previously Installed Signage

Connemara National Park
Sign Location Plan

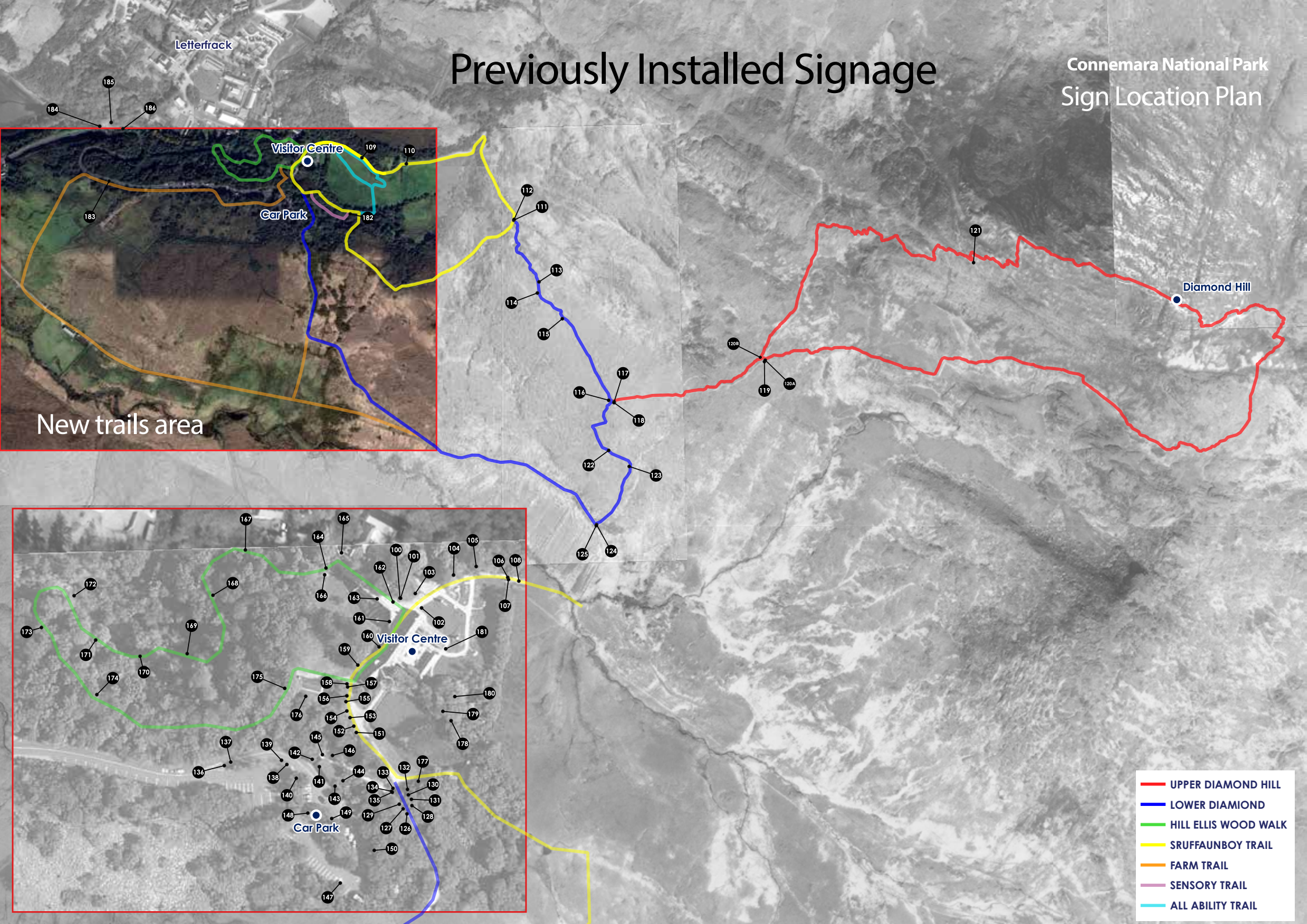

New trails area

Visitor Centre

Car Park

Diamond Hill

Visitor Centre

Car Park

Lettertrack

- UPPER DIAMOND HILL
- LOWER DIAMOND
- HILL ELLIS WOOD WALK
- SRUFFAUNBOY TRAIL
- FARM TRAIL
- SENSORY TRAIL
- ALL ABILITY TRAIL

New Signage Locations

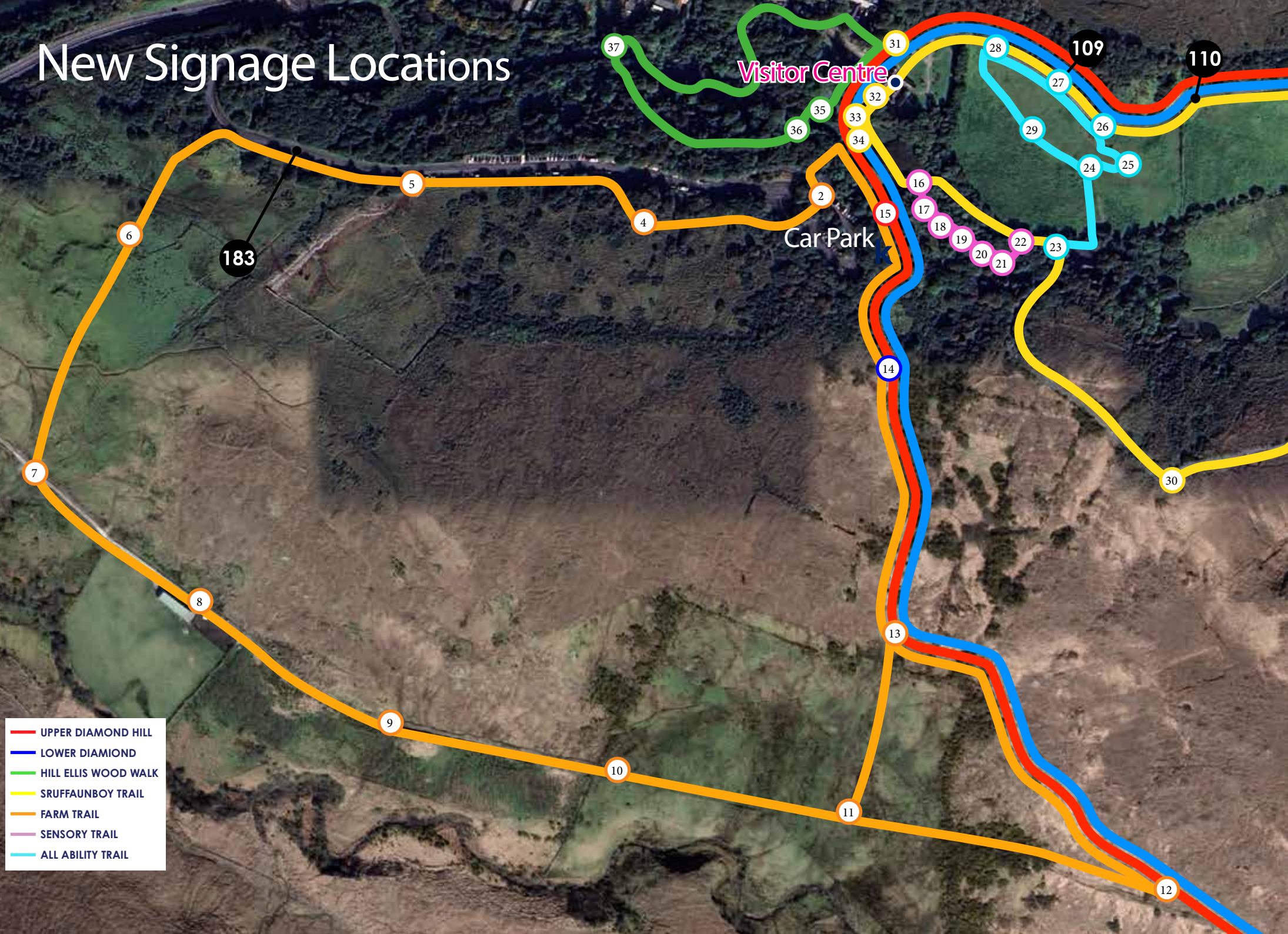

- UPPER DIAMOND HILL
- LOWER DIAMOND
- HILL ELLIS WOOD WALK
- SRUFFAUNBOY TRAIL
- FARM TRAIL
- SENSORY TRAIL
- ALL ABILITY TRAIL

Themes

- 5. Stone walls talking point - Area potentially a meadow TBC
- 6. lookout point - Tully Mountain, Inisbofin, Inishark
- 8. Farm building/Farm Animals (info provided)
- 9. ATU Community Woodland - (content already produced - Eugene to send)
- 12. Bog restoration (area a little further along lower diamond walk)
- 14. Plants along the Blue Trail
- 17. Wildlife of the Park (Info provided)
- 18. Pollinators (Info provided)
- 24. Control of Non-Native invasive species (Info provided)
- 25. Glacial landscape formation (Info provided)
- 27. Plants along the Yellow Trail
- 31. Eco Enclave (designed by students)
- 32. Site Layout and History (info provided)
- 36. Hydro Room
- 39. SAC and Habitats

Sign Panel Dimensions & Setting Out

Small Square Panel - Single Size

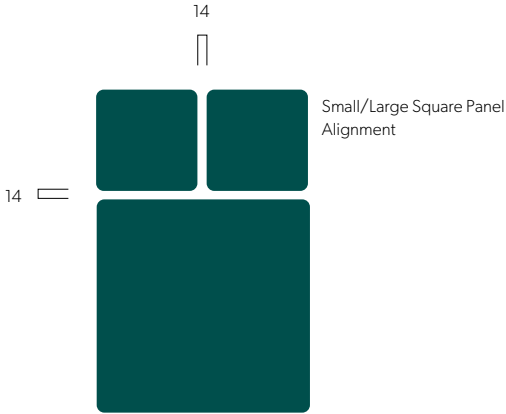
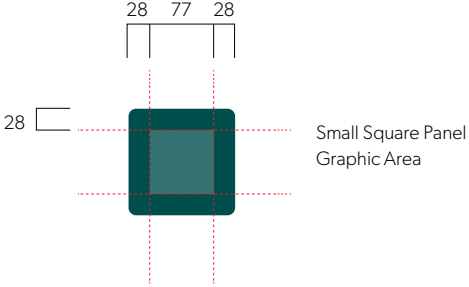
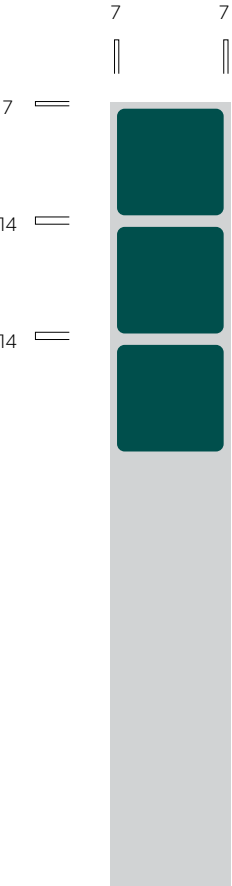
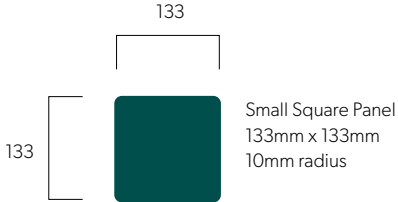

Large Square Panel - Single Size

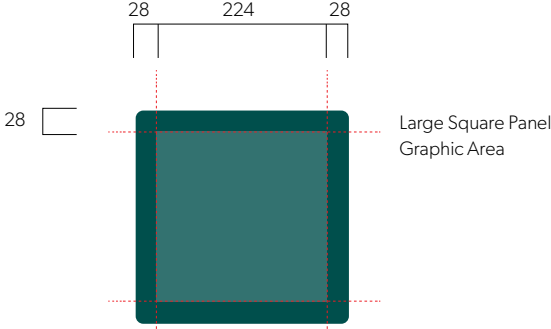
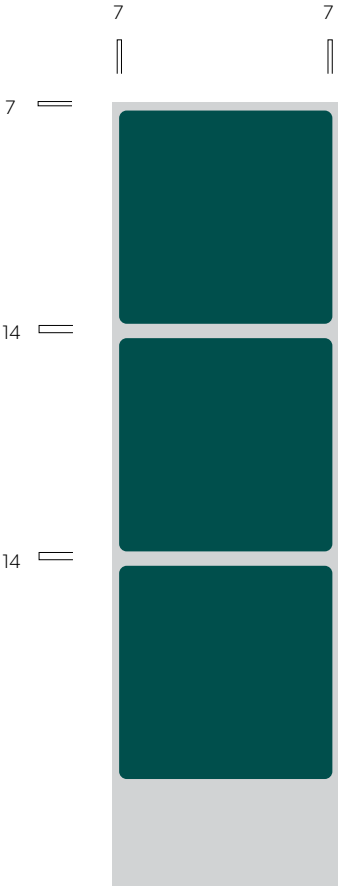
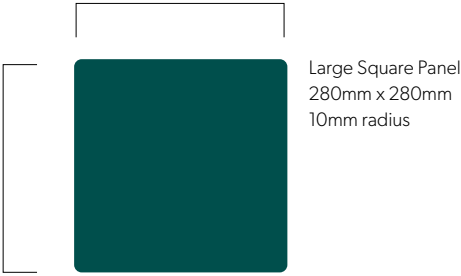

Large Square Panel
Spacing



Sign Type D Information Totem



Sign Type E Access



Sign Type F Small Directional Totem



Sign Type G2 Medium Directional Totem



Sign Type G1 Large Directional Totem



Sign Type H1 Large Sign Plate
For fixing to existing walls and fencing



Sign Type H2 Small Sign Plate
For fixing to existing walls and fencing

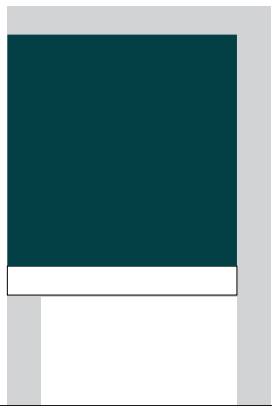

Sign Type A1 Welcome Sign

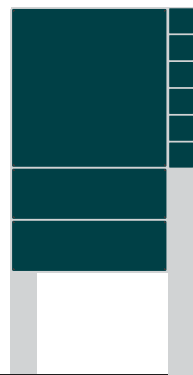

Sign Type A2
Entrance Information Sign



Sign Type B1
Car Park Directional
& Information Sign

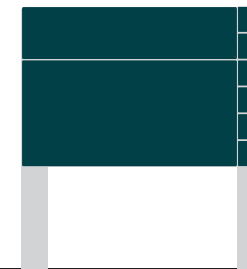

Sign Type B2
Car Park Directional
& Information Sign

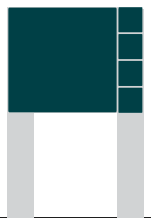

Sign Type C
Car Park Directional
& Information Sign

Sign Panel Dimensions & Setting Out

Large Square Panel - Multiple Sizes

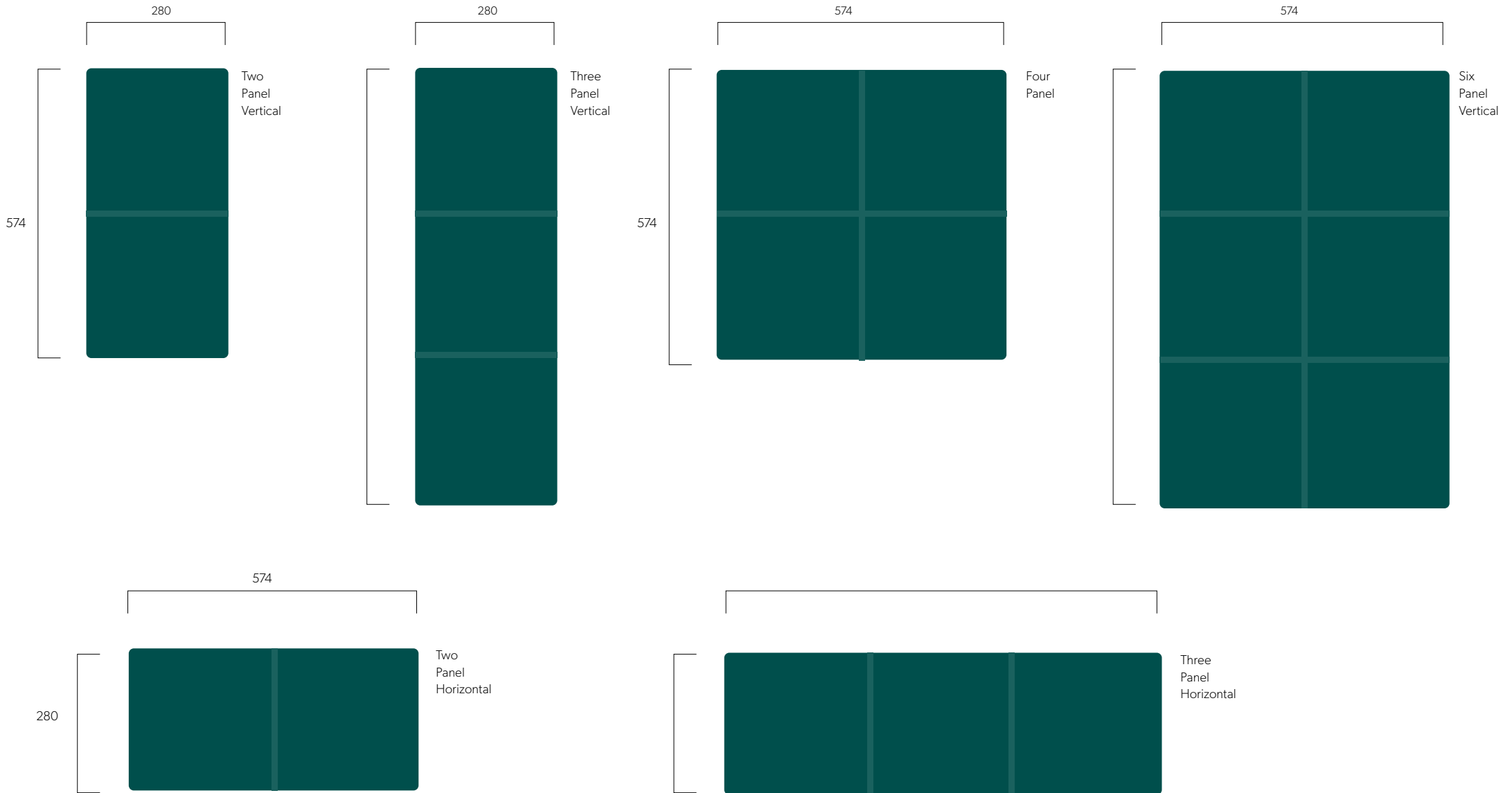

Sign Panel Dimensions & Setting Out

Large Square Panel - Multiple Sizes

1162

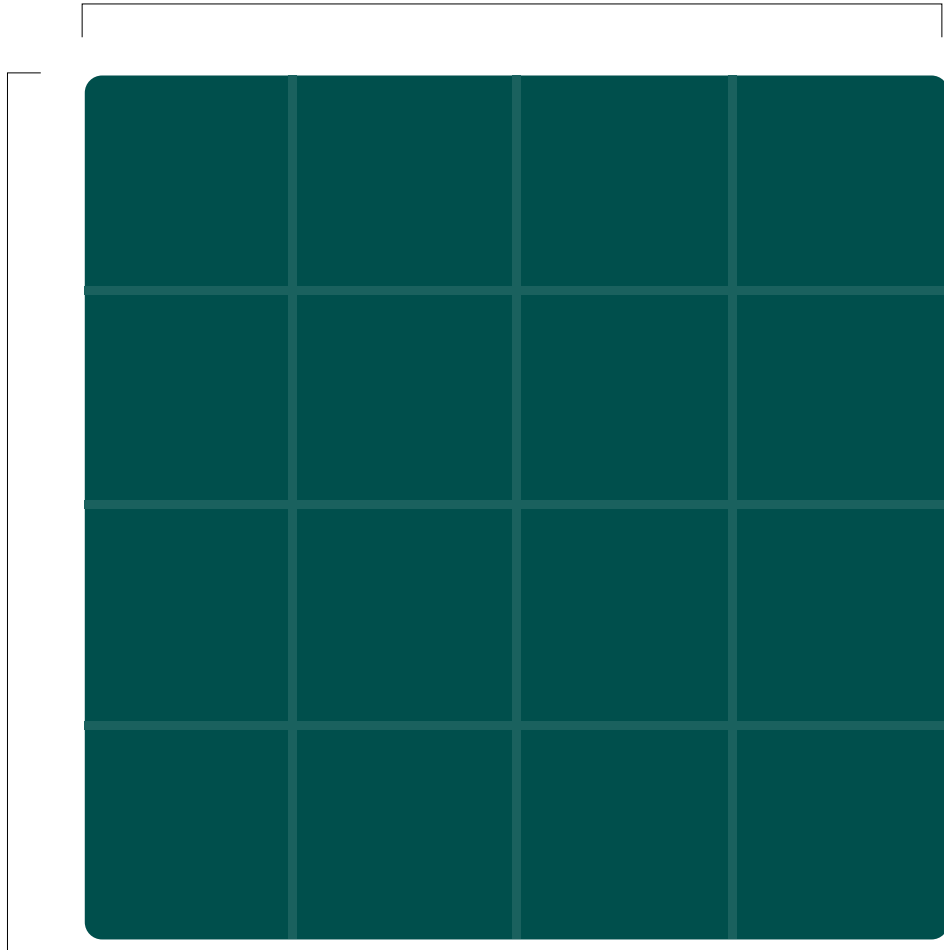

Sixteen Panel

868

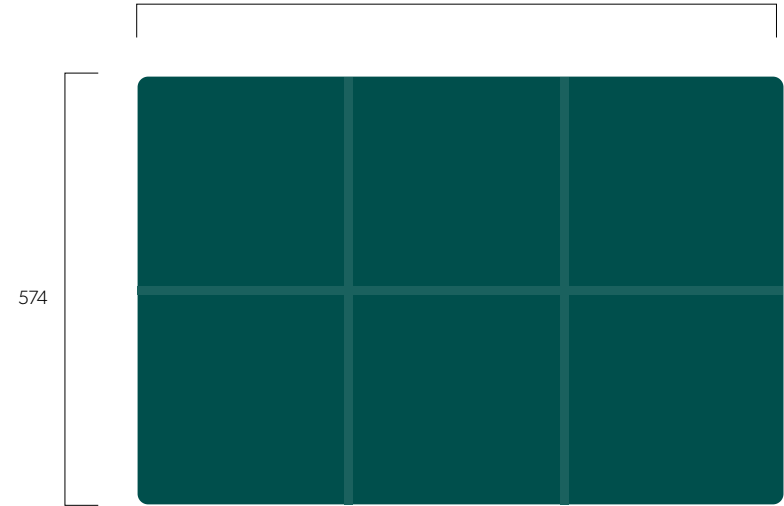

Six Panel Horizontal

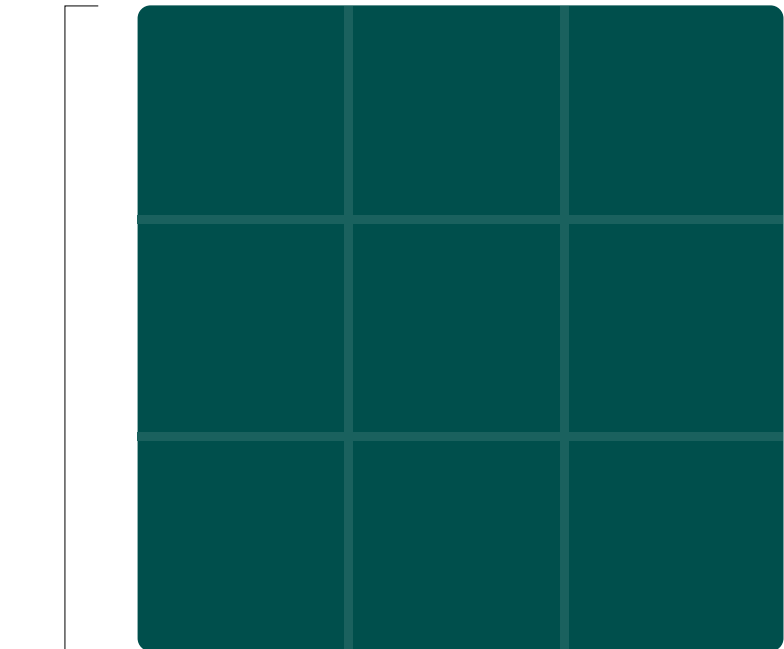

Nine Panel

Trail Colour Definitions

Connemara National Park



Upper Diamond Hill

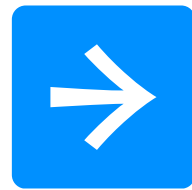

Lower Diamond Hill



Farm Trail



Sensory Trail



Ellis Wood Nature



Sruffaunboy

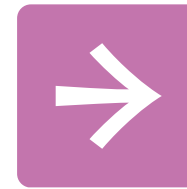

All Ability

National Parks

Wayfinding graphic system

Icons indicate trail type.



Multi-access



Easy



Moderate



Strenuous



Very Difficult

New Wayfinding & Interpretation Signage

Connemara National Park



New Wayfinding & Interpretation Signage

1. Removed
2. **Accessible Lectern Sign + WF Reduced Height Large Directional Totem**
 - 1no. Map Panel (868 x 574)
 - 2no. Farm trail, Visitor Centre Panel (280 x 280)
 - 1no. Protect Nature Panel (280 x 574)
3. Removed
4. **WF Small Directional Totem**
 - 4no. Farm trail Arrow, Car Park, Visitor Centre Panel (133 x 133)
5. **Accessible Lectern Sign + Solar Audio Player (Sensory)**
 - 1no. Stone Walls (Potentially meadow here) (868 x 574)
 - 1no. Solar Audio Player
6. **Accessible Lectern Sign (2no.) + Spotting scope (Sensory)**
 - 1no. Accessible Lectern Sign - Tully Mountain, Inisbofin, Inishark Panel (868 x 574)
 - 1no. Accessible Lectern Sign Map Panel (868 x 427)
 - 3no. Farm trail, Car Park, Visitor Centre Panel (133 x 133)
 - 1no. Spotting scope
7. **Accessible Lectern Sign + WF Small Directional Totem**
 - 5no. Farm Trail, Upper Diamond Trail, No Entry, No Entry (133 x 133)
8. **Accessible Lectern Sign + Rotating Wooden Totem (Sensory)**
 - 1no. Farm building/Farm animals (868 x 574)
 - 1no. Rotating Wooden Totem (Farm Animals)
9. **Accessible Lectern Sign**
 - 1no. ATU Community Woodland (868 x 574)
10. Removed
11. **WF Small Directional Totem**
 - 12no. Farm Trail Arrow, Blue Arrow, Red Arrow, Parking, Visitor Centre (133x133)
12. **Accessible Lectern Sign (2no.) + WF Reduced Height Large Directional Totem**
 - 1no. Bog restoration Panel (868 x 574)
 - 1no. Map panel (868 x 427)
 - 6no. Farm Trail Arrow, Red Arrow, Blue Arrow, Visitor Centre Panel (133 x 133)
 - 6no. Lower Diamond, Farm Trail, Upper Diamond Panel (280 x 280)
 - 1no. Protect Nature Panel (280 x 574)
13. **Accessible Lectern Sign + WF Reduced Height Large Directional Totem**
 - 1no. Map panel (868 x 574)
 - 7no. Farm Trail, Lower Diamond Walk, Upper Diamond Walk Panel (280 x 280)
14. **Accessible Lectern Sign + Flower Talk Tube (Sensory)**
 - 1no. Plants found along blue trail (info provided) (868 x 574)
 - 2no. Flower Talk Tube
15. *See replacement/amended signs 8 & 9 (originally 126 and 127)*
16. **WF Reduced Height Large Directional Totem**
 - 1no. Sensory Trail Title Panel (280 x 280)
17. **Accessible Lectern Sign + Relief engravings (Sensory)**
 - 1no. Wildlife of the Park with engravings (868 x 574)
18. **Freestanding Sign + Flower Talk Tube (Sensory)**
 - 1no. Pollinators Interactive sign with rotating disc
 - 2no. Flower Talk Tube
19. Removed
20. Removed
21. **Freestanding Sign (Sensory)**
 - 1no. Connemara Under Your Fingertips - Concealed touch openings with textures inside - Guess what they are.
22. **Accessible Lectern Sign + WF Reduced Height Large Directional Totem**
 - 1no. Geology Panel (868 x 574)
 - 1no. Sensory Trail Title Panel (280 x 280)
23. **Accessible Lectern Sign + WF Reduced Height Large Directional Totem**
 - 1no. Map Panel (868 x 574)
 - 2no. All Ability Title Panel (280 x 280)
24. **Accessible Lectern Sign + WF Small Directional Totem**

New Wayfinding & Interpretation Signage

1no. Control of invasive species (868 x 574)

6no. All Ability Arrow, Visitor Centre (133 x 133)

25. Freestanding Sign (Sensory)

1no. Freestanding sign with physical glacial bolder - drag across the sign to create a valley (stone scraping and vibration)

26. WF Reduced Height Large Directional Totem + WF Small Directional Totem

1no. Ability Trail Title (280 x 280)

11no. All Ability Arrows, Yellow Arrows, Blue Arrows, Red Arrows, Visitor Centre Panel (133 x 133)

27. Accessible Lectern Sign (109 on original)

1no. Plants found along yellow trail Panel (868 x 574)

28. WF Small Directional Totem + WF Reduced Height Large Directional Totem

8no. All Ability Arrows, Yellow Arrows, Blue Arrows, Red Arrows, Visitor Centre Panel (133 x 133)

1no. All Ability Arrows Title Panel (280 x 280)

29. Freestanding Chimes (Sensory)

1no. Nature chimes - Play the sequence of nature

30. Accessible Lectern Sign

1no. SAC and Habitats (868 x 574)

31. Accessible Lectern Sign (+ Potential Audio Bench)(Sensory)

1no. Eco Enclave information (868 x 574)

1no. Audio Bench

32. Freestanding Sign

1no. Site Layout history interactive with rotating disc to reveal info

33. Accessible Lectern Sign

1no. Cows and sheep (Replacing existing sign?) (868 x 574)

34. Accessible Lectern Sign

1no. Beekeepers Association (868 x 574)

35. Freestanding Sign (Sensory)

1no. Smells of the Forest - 5 aromas that people sniff and guess what they

are. - A lift up flap gives the answer

36. Accessible Lectern Sign

1no. Hydro room intake (868 x 574)

37. Freestanding Sign (Sensory)

1no. Guess the age by spinning the tree sections

QUANTITIES

- 20no. Accessible Lectern Signs (*Sign Type E*)
- 8no. Reduced Height Large Directional Totem (*Sign Type G2*)
- 6no. Small Directional Totem (*Sign Type F*)
- 1no. Solar Audio Players for Accessible Lectern Signs (Sensory)
- 1no. Solar Audio Bench (Sensory)
- 1no. Spotting Scope (Sensory)
- 18no. Panels (868 x 574)
- 21no. Panels (280 x 280) (*Large Square Panel*)
- 2no. Panels (280 x 574)
- 55no. Panels (133 x 133) (*Small Square Panel*)
- 2no. Panels (868 x 427)
- 8no. Sensory Elements (various sizes and builds)
 - Rotating Wooden Totem
 - Flower Talk Tube x2
 - Guess the texture
 - Move the Glacial bolder
 - Chimes
 - Smells of the Forest
 - Guess the Tree Age

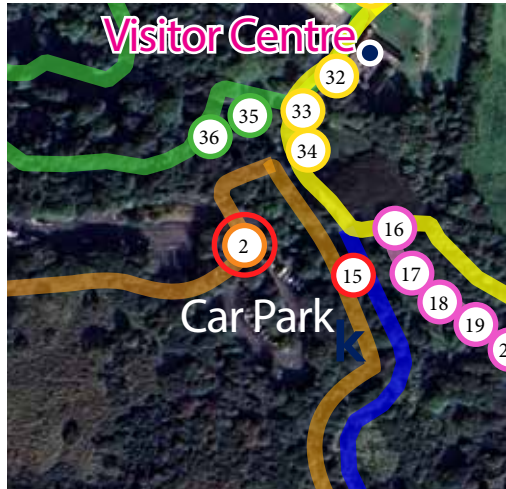

Sign Type E
Accessible Lectern Sign

Identifier Code
1-N60-001

Panel Requirements
1 x (868 x 574) panel



Position
Left of trail entrance

Páirc Náisiúnta Chonamara
Connemara National Park

Cineálacha Cosán
Types of Trail

- Cosán Breathna** / **Trail** - Míle métreanna Cosán náisiúil agus choilteanna. Oibríocht do gach aois agus leibhéal. Taitéamh tréimh, taitéamh do na h-athair.
- Éasca** / **Easy** - Rosáin tairbh réidhe. Oibríocht do ghluaise treabhagh. Cosán gearr métreanna. Suidh ar an t-athair gearr.
- Méasúrtha** / **Moderate** - Rosáin méide méide agus aibíocht náisiúil. Oibríocht do dhá mhéadar aibíocht náisiúil. Taitéamh tréimh, taitéamh do na h-athair. Suidh ar an t-athair gearr.
- Dúis** / **Difficult** - Méide gearra agus dúis. Oibríocht náisiúil. Oibríocht do dhá mhéadar aibíocht náisiúil. Taitéamh tréimh, taitéamh do na h-athair. Suidh ar an t-athair gearr.
- An-dúis** / **Very Difficult** - Méide gearra féide agus aibíocht náisiúil. Oibríocht do dhá mhéadar aibíocht náisiúil. Taitéamh tréimh, taitéamh do na h-athair. Suidh ar an t-athair gearr.

Treoir maidir le Cosán Trail Guide

Cosán Breathna Trail	• 200m • 100m • 100m • 100m	Cosán gearrthéim náisiúil a bhfuil méide gearra agus aibíocht náisiúil ann. Oibríocht do gach aois agus leibhéal. Taitéamh tréimh, taitéamh do na h-athair.	Cosán gearrthéim náisiúil a bhfuil méide gearra agus aibíocht náisiúil ann. Oibríocht do gach aois agus leibhéal. Taitéamh tréimh, taitéamh do na h-athair.	Cosán Breathna Trail	• 1000m • 100m • 100m • 100m	Cosán gearrthéim náisiúil a bhfuil méide gearra agus aibíocht náisiúil ann. Oibríocht do gach aois agus leibhéal. Taitéamh tréimh, taitéamh do na h-athair.	Cosán gearrthéim náisiúil a bhfuil méide gearra agus aibíocht náisiúil ann. Oibríocht do gach aois agus leibhéal. Taitéamh tréimh, taitéamh do na h-athair.	Cosán Breathna Trail	• 100m • 100m • 100m • 100m	Cosán gearrthéim náisiúil a bhfuil méide gearra agus aibíocht náisiúil ann. Oibríocht do gach aois agus leibhéal. Taitéamh tréimh, taitéamh do na h-athair.	Cosán gearrthéim náisiúil a bhfuil méide gearra agus aibíocht náisiúil ann. Oibríocht do gach aois agus leibhéal. Taitéamh tréimh, taitéamh do na h-athair.
--------------------------------	--------------------------------------	---	---	--------------------------------	---------------------------------------	---	---	--------------------------------	--------------------------------------	---	---

NPWS
Náisiúnta Parcraíocht
National Parks and Wildlife Service

Páirc Náisiúnta
National Parks

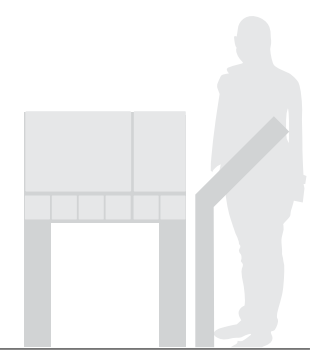

Sign Location 02

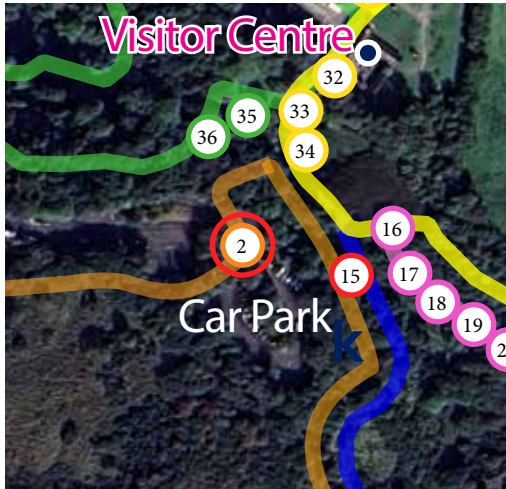

Sign Type G2
Reduced Height Large
Directional Totem

Identifier Code
1-N60-002

Panel Requirements
1 x (280 x 280) panel
1 x (280 x 574) panel

FT_Title_01

Side A



Side C



L-GEN-102-TP-G2-D1.pdf
Existing print ready artwork

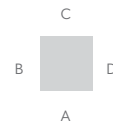

Position
Left of trail entrance

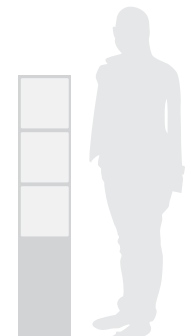

Sign Location 04



Sign Type F
Small Directional Totem

Identifier Code
1-N60-003

Panel Requirements
4 x (133 x 133) panels

Notes
Replaces existing sign
Match orientation

Side A



Side C



Position
Right side of trail

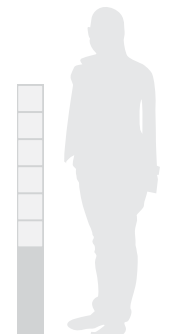

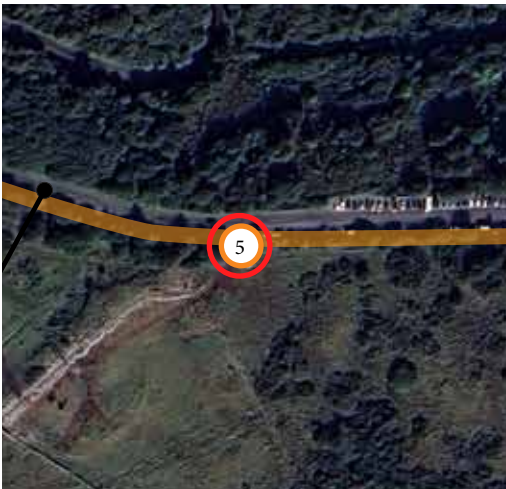

Sign Type E
Accessible Lectern Sign

Identifier Code
1-N60-004

Panel Requirements
1 x (868 x 574) panel

**Stone walls
Meadow
+Solar Audio Player**



Notes
New sign with map

Position
To left of the gate in front
of the stone pillar.

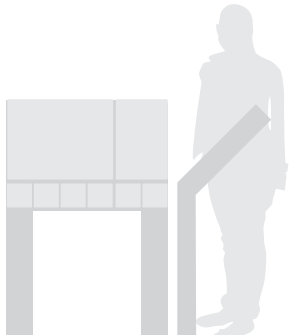

Sign Location 06



Sign Type E
Accessible Lectern Sign

Identifier Code
1-N60-005

Panel Requirements
1 x (868 x 427) panel
3 x (133 x 133) panels

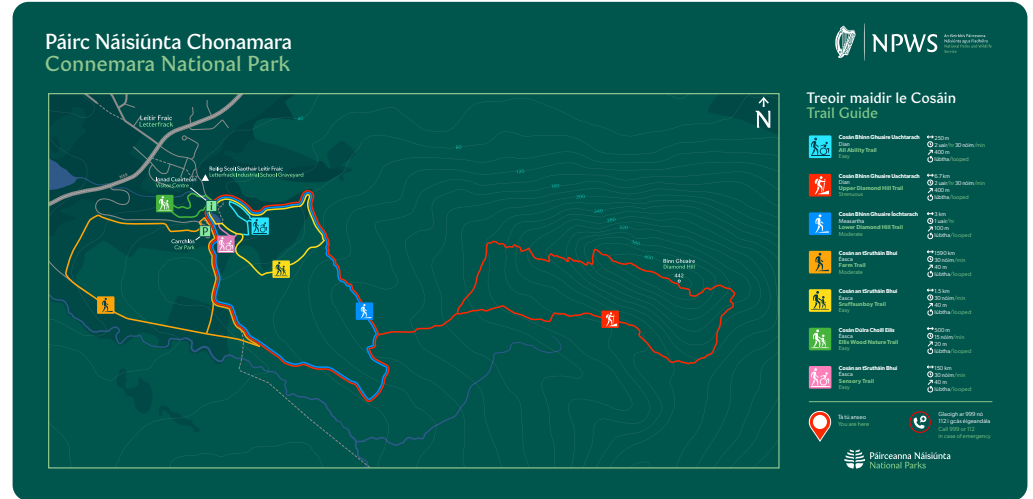

Position
In lookout point alcove

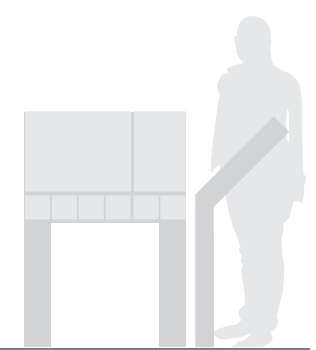



Sign Type E
Accessible Lectern Sign

Identifier Code
1-N60-006

Panel Requirements
1 x (868 x 574) panel



Position
In lookout point alcove



Lookout Point
Tully Mountain
Inisbofin
Inishark

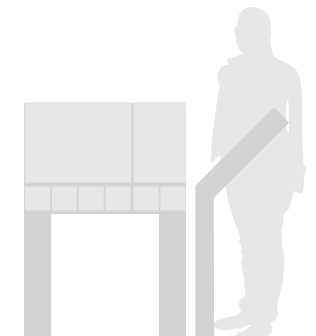



**Waterproof Outdoor
Binoculars with step**

Identifier Code

1-N60-007

Panel Requirements

.....



Position

In lookout point alcove



Sign Location 7



Sign Type F
Small Directional Totem

Identifier Code
1-N60-008

Panel Requirements
5 x (133 x 133) panels

Notes
Small Directional Totem
(126 in previous report)

Side B



Side A



Side D



Position
At T junction





Sign Type E
Accessible Lectern Sign

Identifier Code
1-N60-009

Panel Requirements
1 x (868 x 574) panel



Position
Left of farm building gate



Farm building
Farm animals

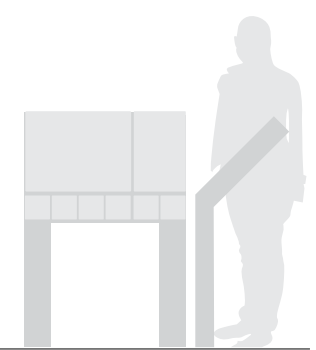



Sensory Element
Rotating Wooden Totem

Identifier Code
1-N60-010

Panel Requirements
....



Position
Left of farm building gate



3no. Solid hardwood cylinder/trunk sections stacked viertically - oak, iriko or similar.

With CNC images of 3x farm animals that the user can align.

Sealed bearings inside each for smooth rotation.

Mounted onto central rod with welded base plate fixed into concrete pad





Sign Type E
Accessible Lectern Sign

Identifier Code
1-N60-011

Panel Requirements
1 x (868 x 574) panel



Position
In front of the stone wall

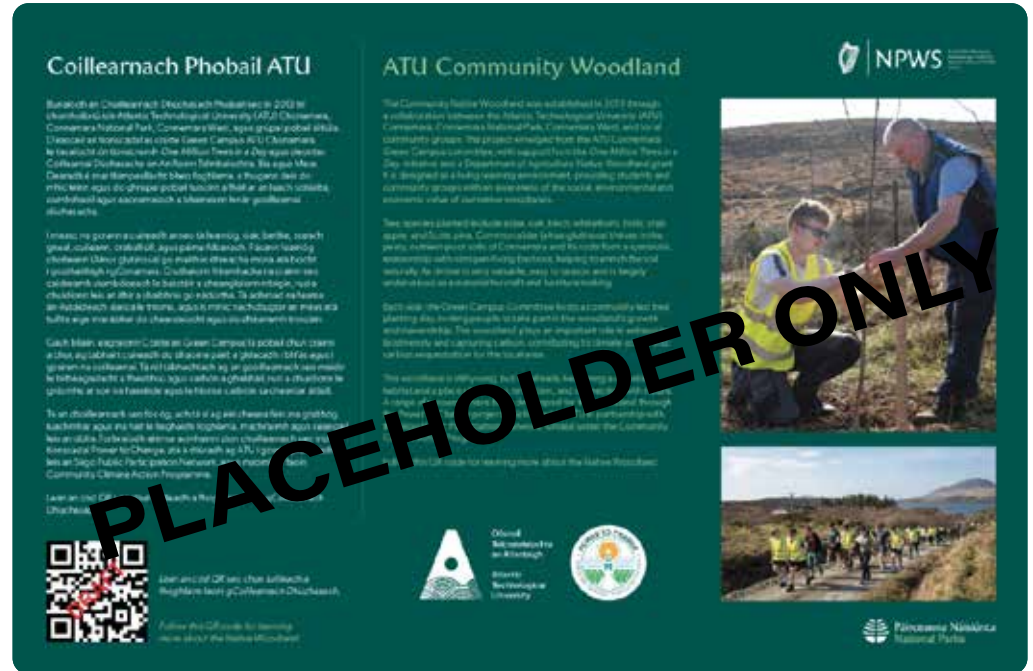

ATU Community Woodland

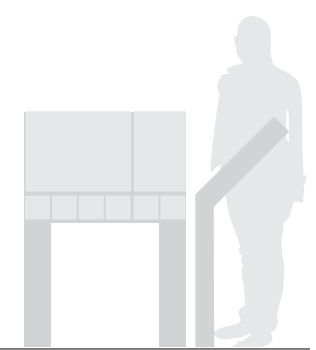

Sign Location 11



Sign Type F
Small Directional
Totem

Identifier Code
1-N60-012

Panel Requirements
12x (133 x 133) panels

Notes
Replaces existing sign
Match orientation

L-GEN-115-IP-F-A2.pdf
Existing print ready
artwork

Position
On right of path

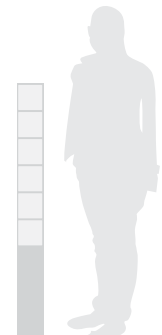



Sign Type E
Accessible Lectern Sign

Identifier Code
1-N60-013

Panel Requirements
1 x (868 x 574) panel



Position
To right side of trail overlooking peatland



LG_Panel_007.pdf

Bog restoration

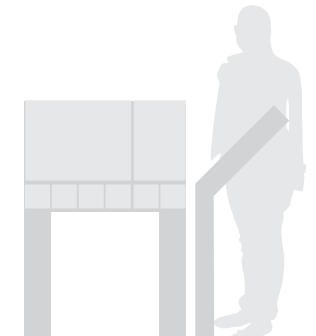

Sign Location 12



Sign Type G2
Reduced Height Large
Directional Totem

Identifier Code
1-N60-014

Panel Requirements
6 x (280 x 280) panel
1 x (280 x 574) panel



Position
To right side of trail overlooking
peatland. Side A visible coming
from Farm Trail

Side A

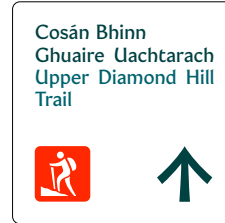
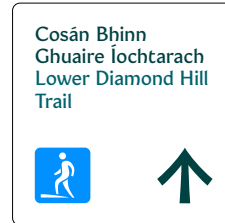

Side B

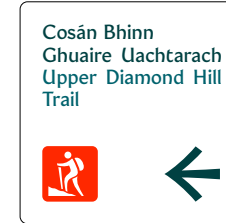
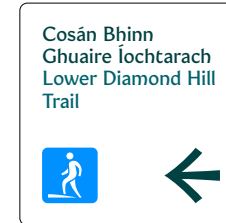

Side C



L-GEN-102-TP-G2-D1.pdf
Existing print ready artwork

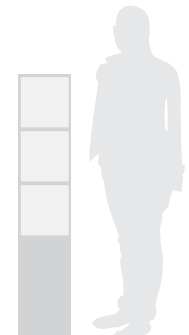
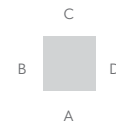

Sign Location 12



Sign Type E
Accessible Lectern Sign

Identifier Code
1-N60-015

Panel Requirements
1 x (868 x 427) panel
6x (133 x 133) panels



Position
To right side of trail overlooking peatland

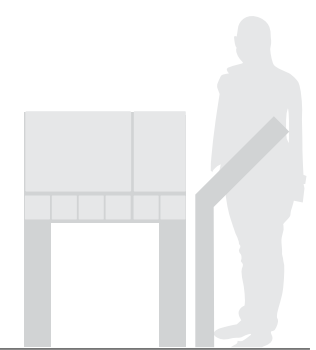
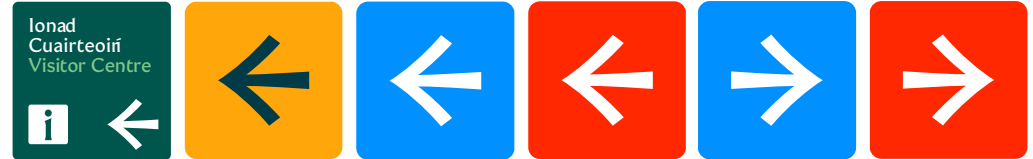
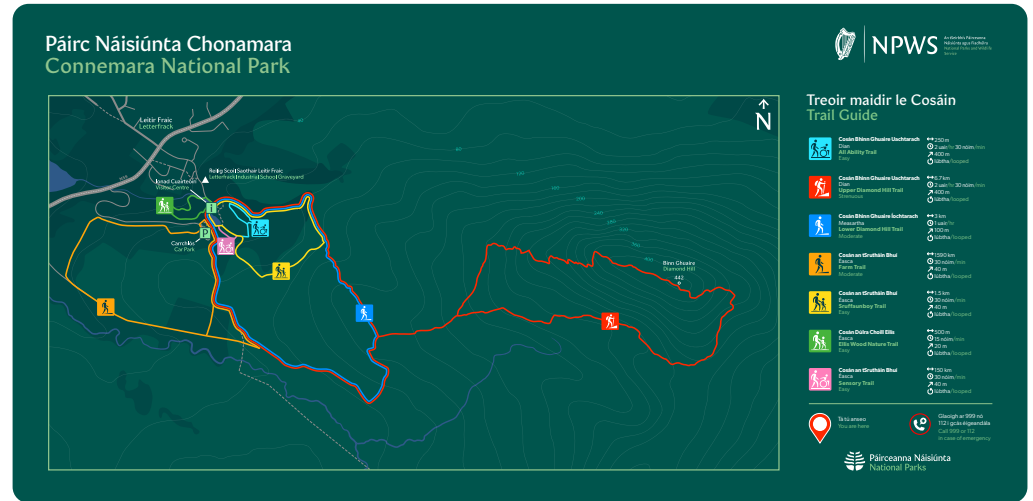

Sign Location 13



Sign Type G2
Reduced Height Large
Directional Totem

Identifier Code
1-N60-016

Panel Requirements
7 x (280 x 280) panel

















Position

Side A

Side B

Side D

<p>Cosán Bhinn Ghuaire Íochtarach Lower Diamond Hill Trail</p>  	<p>Cosán Bhinn Ghuaire Íochtarach Lower Diamond Hill Trail</p>  	<p>Cosán Dúlra Choill Eilís Farm Trail</p>  
<p>Cosán Bhinn Ghuaire Uachtarach Upper Diamond Hill Trail</p>  	<p>Cosán Bhinn Ghuaire Uachtarach Upper Diamond Hill Trail</p>  	<p>Cosán Dúlra Choill Eilís Farm Trail</p>  
<p>Cosán Dúlra Choill Eilís Farm Trail</p>  		

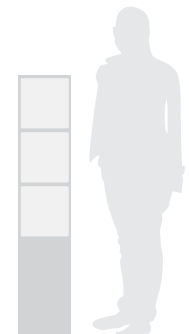
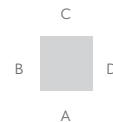

Sign Location 13



Sign Type E
Accessible Lectern Sign

Identifier Code
1-N60-017

Panel Requirements
1 x (868 x 574) panel



Position

Páirc Náisiúnta Chonamara
Connemara National Park

Cineálacha Cosán
Types of Trail

- Cosán Breacchra** / Mixed access Cosán
níodh agha chothroma, Oileadh do gach
an chosáir. Níl aonach leath, b'fhéidir
fóir do bheathn.
- Easca** / Easy Rosnt Rosnt ríodh. Oileadh do
ghnóthraigh, Síon gairne m'ádh. Suidh
leath breacchra.
- Measúrtha** / Measúrtha Rosnt meáil agha
níodh agha chothroma. Oileadh do bheathn
a b'fhéidir leath agha. Tá agha chothroma
leathraigh. Síon gairne m'ádh do bheathn.
Suidh leath agha leathraigh m'ádh.
Agha chothroma leathraigh.
- Dúin** / Streannna Meáil gairne agha doimhne
níodh agha chothroma. Oileadh do bheathn
a b'fhéidir leath agha. Tá agha chothroma
leathraigh. Síon gairne m'ádh do bheathn.
Suidh leath agha leathraigh m'ádh.
Agha chothroma leathraigh.
- An-dúin** / Veas Dúin Meáil gairne leath agha
níodh agha chothroma. Oileadh do bheathn
a b'fhéidir leath agha. Tá agha chothroma
leathraigh. Síon gairne m'ádh do bheathn.
Suidh leath agha leathraigh m'ádh.
Agha chothroma leathraigh.

Treoir maidir le Cosán Trail Guide

<p> Cosán Breacchra Mixed Access Trail</p> <p> Easca Easy Rosnt Rosnt</p> <p> Measúrtha Measured Trail</p> <p> Dúin Streannna Meáil</p>	<p> Cosán Breacchra Mixed Access Trail</p> <p> Easca Easy Rosnt Rosnt</p> <p> Measúrtha Measured Trail</p> <p> Dúin Streannna Meáil</p>	<p> Cosán Breacchra Mixed Access Trail</p> <p> Easca Easy Rosnt Rosnt</p> <p> Measúrtha Measured Trail</p> <p> Dúin Streannna Meáil</p>	<p> Cosán Breacchra Mixed Access Trail</p> <p> Easca Easy Rosnt Rosnt</p> <p> Measúrtha Measured Trail</p> <p> Dúin Streannna Meáil</p>
---	---	---	---

Páircanna Náisiúnta
National Parks

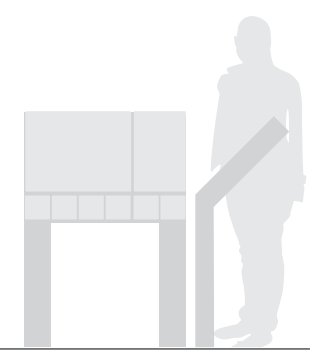

Sign Location 14



Sign Type E
Accessible Lectern Sign

Identifier Code
2-N60-001

Panel Requirements
1 x (868 x 574) panel



Position
To right side of trail
overlooking landscape



Plants on the blue trail
Lower Diamond

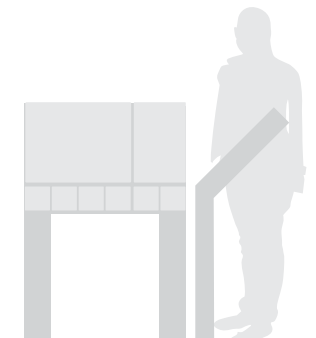

Sign Location 14



Sensory
Flower Talking Tube

Identifier Code
2-N60-002

Panel Requirements
....

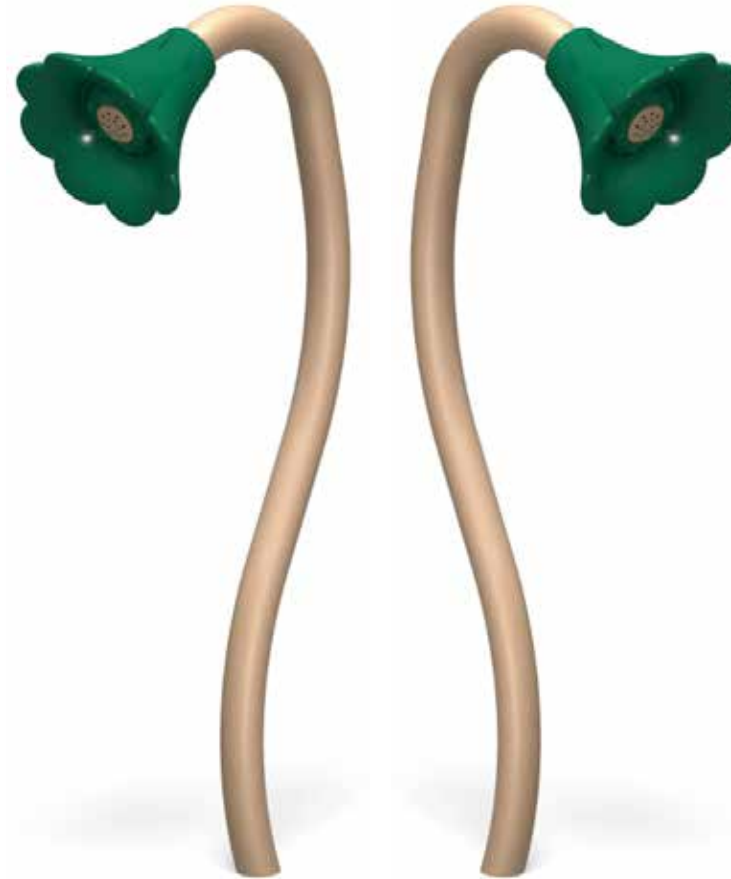

Flower Talk Tube.

Users speak to each other through the tube with the flowers positioned a distance apart along the trail.



Position 1
One flower beside the Accessible
Lectern Sign

Position 2
One flower beside further up the trail



Sign Location 16



Sign Type G2
Reduced Height Large
Directional Totem

Identifier Code
3-N60-001

Panel Requirements
1 x (280 x 280) panel

Side A

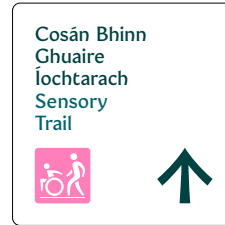

Position
To left of Pony Stables signage

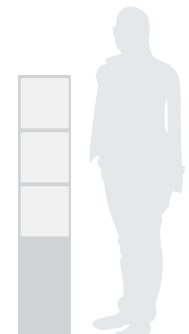
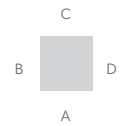



Sign Type E
Accessible Lectern Sign

Identifier Code
3-N60-002

Panel Requirements
1 x (868 x 574) panel



Position
First alcove on boardwalk

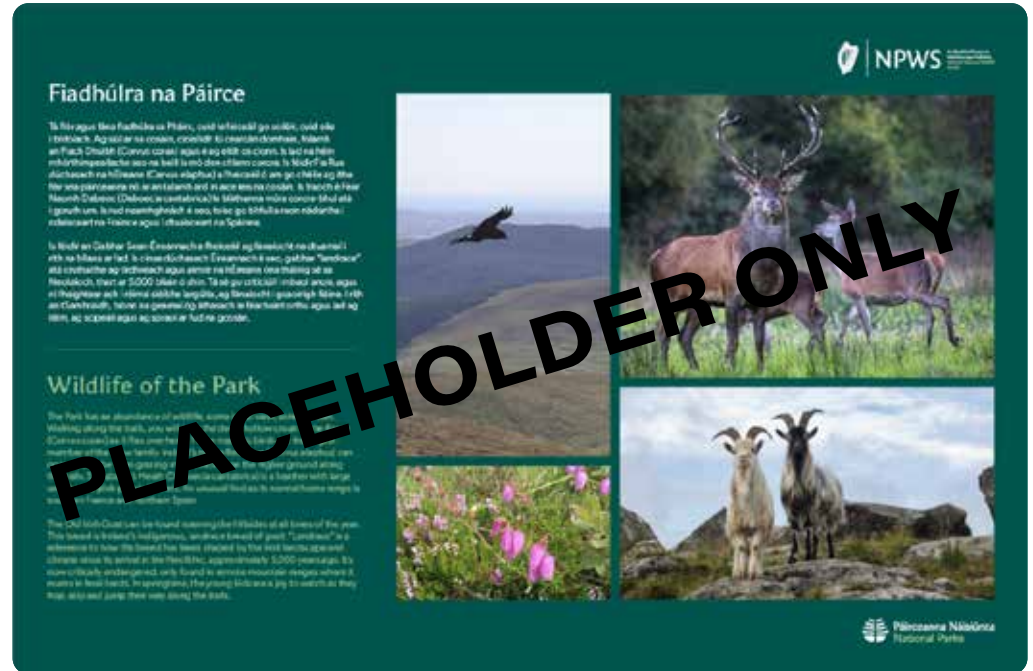

Wildlife of the Park
relief engravings

Description
Panel should include 4no. engravings of selected animals to feel.

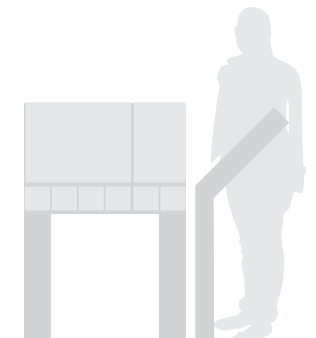

Sign Location 18

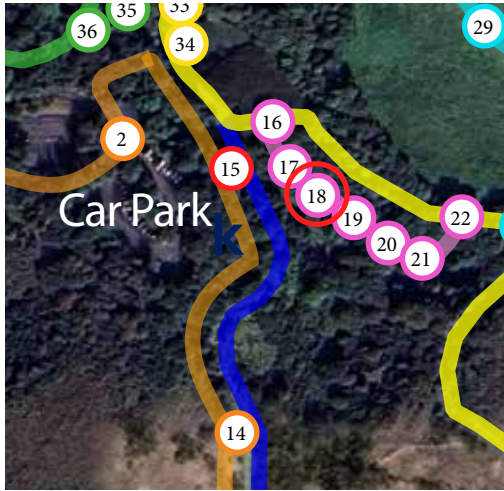

Tactile sign
Rotating Upright sign with rotating discovery disc incl through boardwalk support

Identifier Code

3-N60-003

Panel Requirements

- 1no 1040 x 163
- 1no 800 diam.
- 1no 600 diam.

NOTE:
Signage is mounted on boardwalk - will need suitable mounting - May need to be extended to sink into ground through boardwalk and fix with concrete.

Position
Second alcove on boardwalk

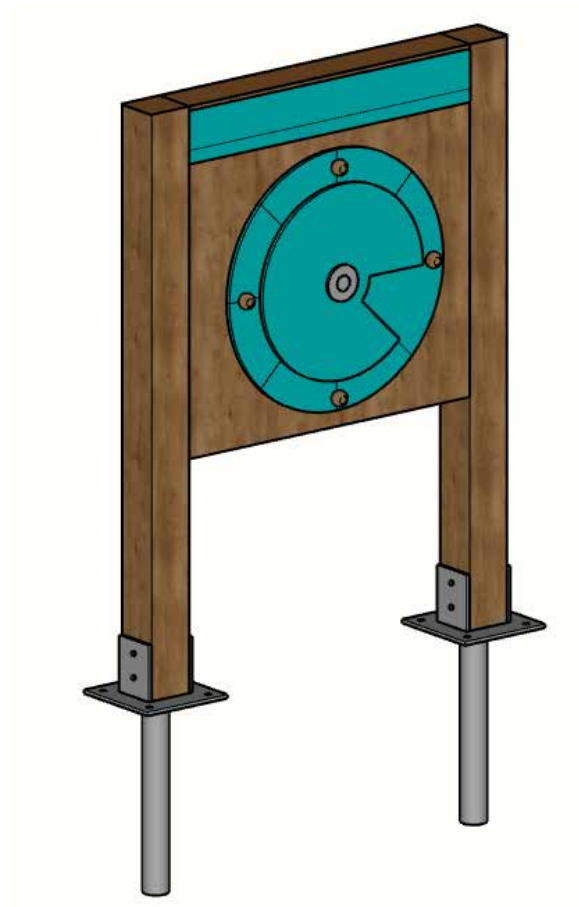

Pollinators

Oak framework in keeping with the style of existing signage.
800mm dia. rotating HDPE backing disc.
600mm dia. external fixed disc with central metal shaft and bearing with click notches.
8no. graphic divisions - Pollinators
Users turn the disc to reveal information about pollinating insects.

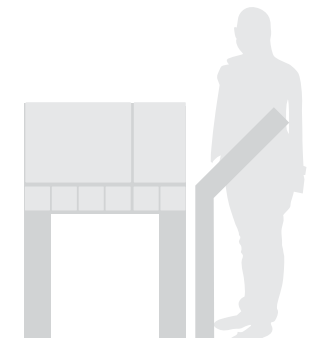

Sign Location 18



Sensory
Flower Talking Tube

Identifier Code
3-N60-004

Panel Requirements
....

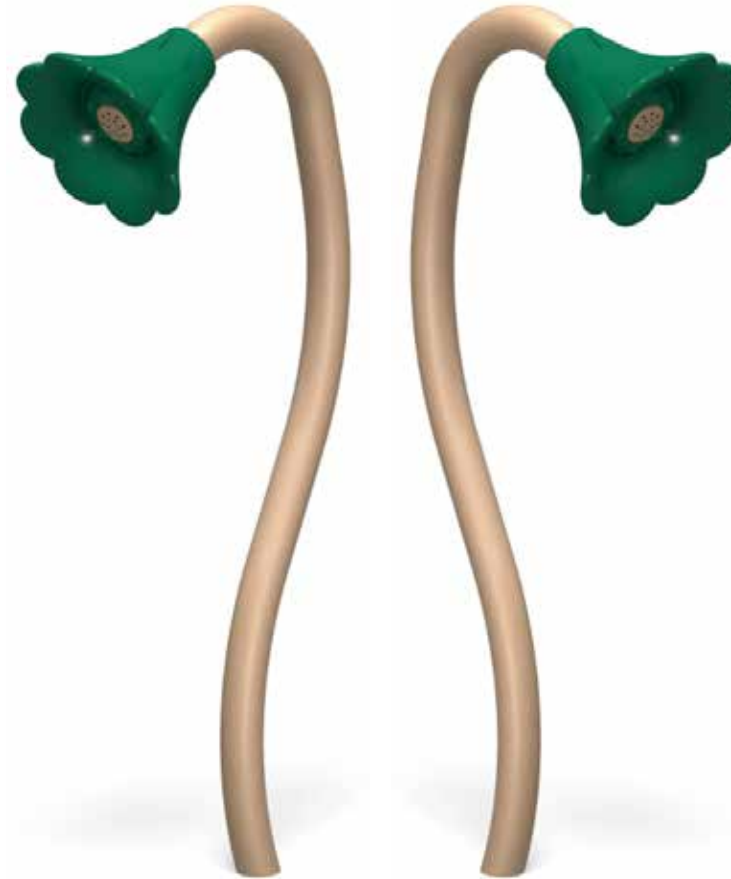

Flower Talk Tube.

Users speak to each other through the tube with the flowers positioned a distance apart along the trail.



Position 1
One flower beside the Accessible
Lectern Sign

Position 2
On opposite side of boardwalk



Sign Location 21



Sensory
Guess the texture
inside concealed opes

Identifier Code
3-N60-005

Panel Requirements
....

NOTE:
Signage is mounted on
boardwalk - will need
suitable mounting
- May need to be
extended to sink into
ground through
boardwalk and fix with
concrete.

Position
Centre of large alcove
on boardwalk

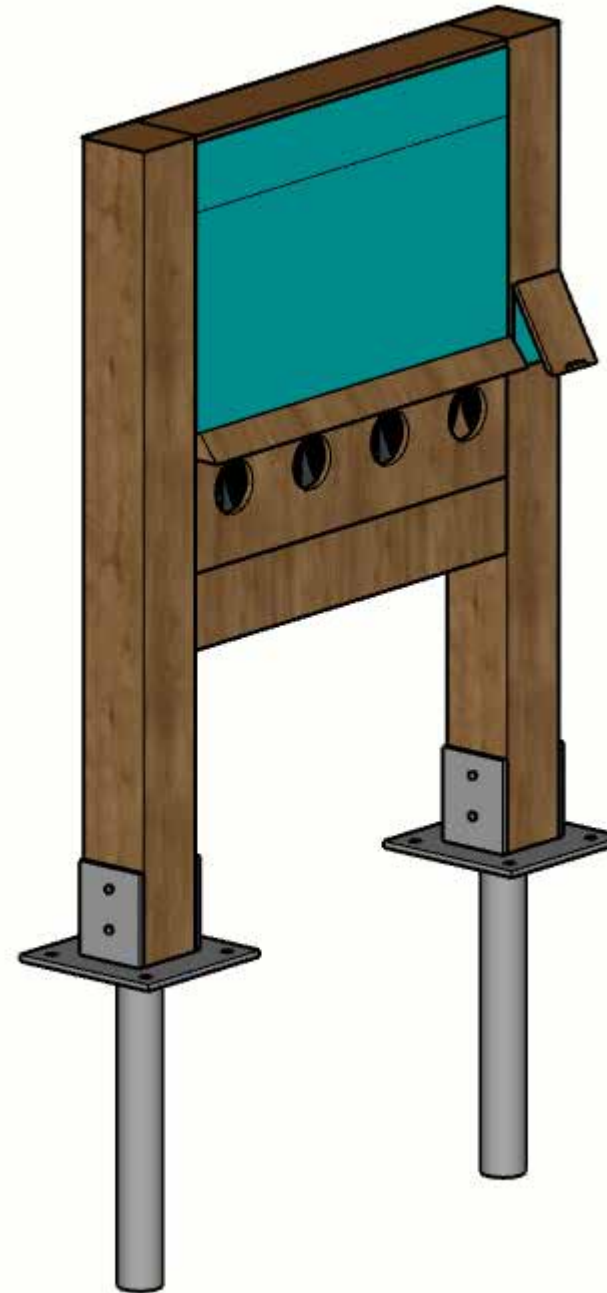

Oak framework in keeping with
the style of existing signage.

Signage with 4no. opes with
UPVC curtains (to obscure view
and reduce water ingress).

‘Connemara Under Your
Fingertips’

Users reach inside the opes and
feel the textures inside to guess
what they are.

An answer flap reveals the
correct answers.



Sign Location 22

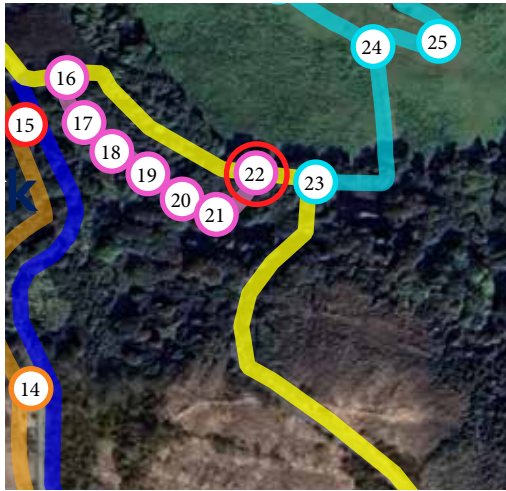

Sign Type G2
Reduced Height Large
Directional Totem

Identifier Code
3-N60-006

Panel Requirements
1 x (280 x 280) panel

Side A



Position
To left of Pony Stables signage

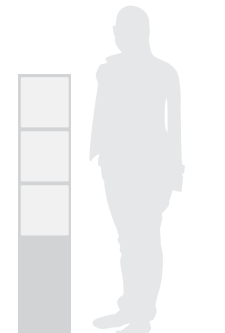
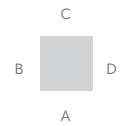

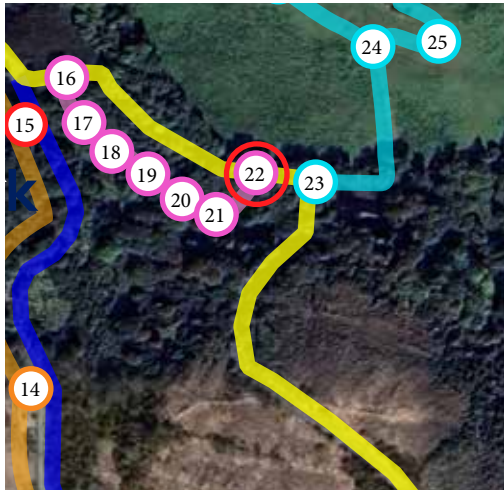

Sign Type E
Accessible Lectern Sign

Identifier Code
3-N60-007

Panel Requirements
1 x (868 x 574) panel

NOTE
Ground to be tarmaced
by National Park before
application of Accessible
Lectern Sign



Position
To left of Pony Stables signage

Téigh i dTeagmháil le Scéal Chonamara

Insíonán tirdheach Chonamara scéal a thosaigh na céadta milliún bliain ó shin. Go domhain faoi aigéin ársa, d'athraigh teas agus brú ollmhór carraigeacha, agus bhíonn magna leáite a bhealach suas trí screamh an Domhain. Le himeacht ama, chruthaigh tógáil sléibhte, creimeadh agus athruithe geolaíochta na carraigeacha iontach atá romhat inniu.

Léiríonn na carraigeacha mórthimpeall ort céimeanna éagsúla den turas neamhghnách seo tríd an am.

Thosaigh Amphibólait mar charraig bhólcánach sular athraigh teas agus brú dian í go domhain laistigh den Domhan.

Tailleadann Marmar-Amphibólait-Scéal roinnt céimeanna d'athru geolaíochta. Athraíodh, fillteadh agus cumascadh carraigeacha éagsúla le chéile, rud a chruthaigh carraig le mianraí codarsnacha agus sraithheanna sainiúla.

Thosaigh Marmar mar aolchloch ar ghriinneall aigéin ársa. D'athraigh teas agus brú ina dhiaidh sin go dtí an charraig chríostalach atá le feiceáil inniu.

Cruthaíodh Porfáir nuair a d'athraigh teas agus brú an Domhain. D'fhás críostal mhór feldspáir sa magma sular athraigh den charraig timpeall orthu.

Breathnaigh níos géire ar na carraigeacha seo agus déan doimhneacht le do shúile. Tá uigean 10 milliún bliain ann ar gach carraig. Moltáigh mína an mharmair, an gharbh na fíocháin agus an t-éireann sa scéal agus na críostal sa phorfáir.

Lean na dhathé poncáithe chun gach cineál carraige a aimsiú. Seasann gach ponc do 10 milliún bliain. Comhair na poncanna chun aoiis gach carraige a fháil amach.

Touch the Story of Connemara

The landscape of Connemara tells a story hundreds of millions of years in the making. Deep beneath ancient oceans, immense heat and pressure transformed rocks, while molten magmas forced its way through the Earth's crust. Over time, mountain building, erosion and geological change created the remarkable rocks you see here today.

The rocks around you represent different moments in this extraordinary journey through time.

Amphibolite began as volcanic rock before intense heat and pressure transformed it deep within the Earth.

Marble-Amphibolite formed over millions of years through a series of geological changes. Different rocks were altered, fused, and pressed together, creating a rock with contrasting textures and colors.

Marble formed from limestone on the floor of an ancient ocean. Heat and pressure transformed it into the crystalline rock we see today.

Feldspar Porphyry formed when molten rock cooled beneath the Earth's surface. Large feldspar crystals grew within the magma before the remaining rock cooled around them.

Take a closer look and use your hands as well as your eyes. Each rock has its own texture, colour and character. Feel the smoothness of marble, the rough texture of amphibolite, the layers within schist and the crystals in feldspar porphyry.

Follow the coloured dotted pathways to discover each rock. Every dot represents 10 million years. Count the dots to discover how old each rock is.

Cuardaigh na siombailí ar na plaiceanna. Look for the symbols on the plaques.

Bólcán
Volcano

Aigéan
Ocean

Teas
Heat

Brú
Pressure

Sraithheanna
Layers



Críostal
Crystals

Fáimíní Carraige
Rock Formation



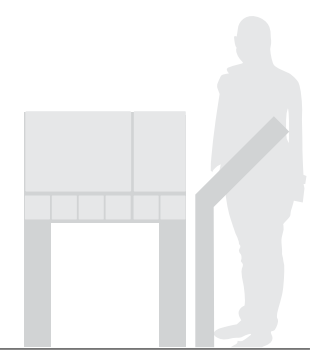

LG_Panel_10.pdf



Sign Location 22

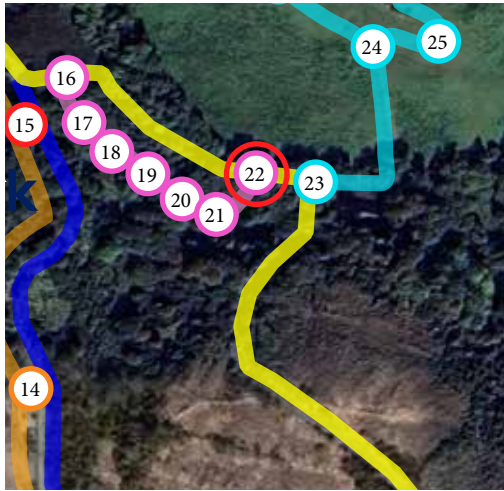

Sign type
Floor Paint

Identifier Code
3-N60-008

Panel Requirements
...

NOTE
Ground to be tarmaced
by National Park before
application of paint



Position
ground area in geology section

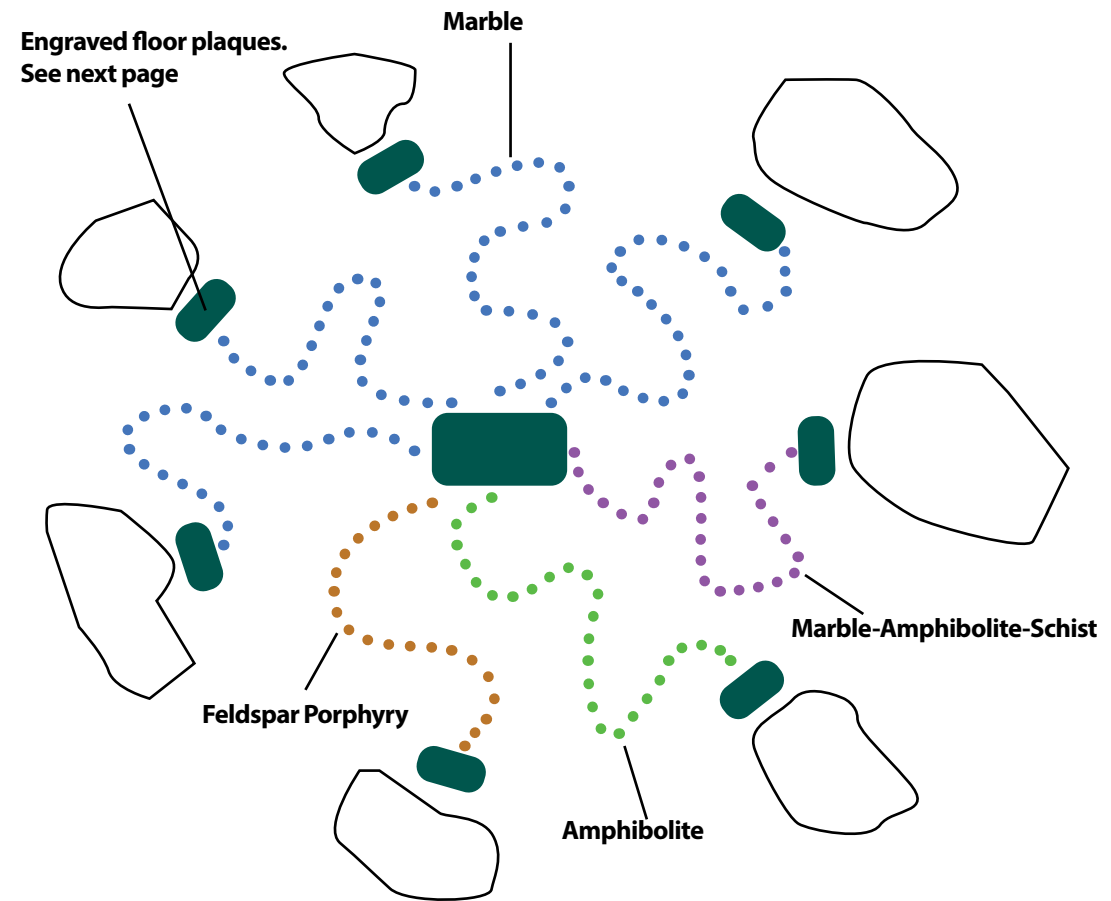

Description
Each of the four types of rock is represented by its own colour. Each dot along the line running from the central panel to the rocks represents 1 million years. Visitors count the dots to find the age.

Sign Location 22

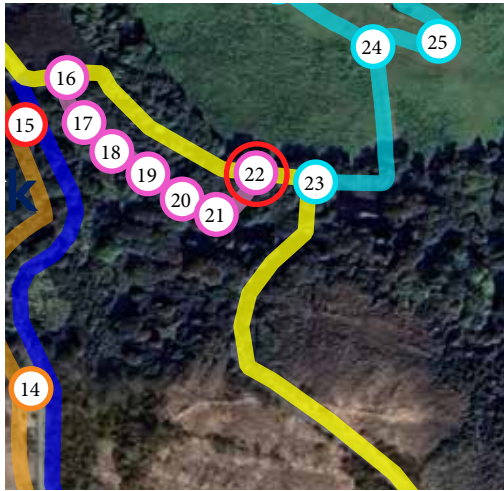

Sign type
Floor plaques x 7

Identifier Code
3-N60-009

Panel Requirements
7no. 300x200

NOTE
Ground to be tarmaced by National Park before application of floor plaques



Position
At the base of each rock

x4

Marmar Marble
500 milliún bliain 500 million years

Touch
Can you feel its rough texture?

Déan Teagmháil
An féidir leat a huigeacht gharbh a mhothú?

x1

Amphibilít Amphibolite
470 milliún bliain 470 million years

Touch
Does it feel smoother than the other rocks?

Déan Teagmháil
An féidir leat a huigeacht níos míne ná na carraigeacha eile?

Marmar-Amphibilít-Sceall
Marble-Amphibolite-Schist
500 milliún bliain 500 million years

Touch
Can you trace the bands and layers with your fingers?

Déan Teagmháil
An féidir leat na bandaí agus na sraitheanna a leanúint le do mhéara?

x1

Porfair Fheidspáir
Feldspar Porphyry
400 milliún bliain 400 million years

Touch
Can you find the larger crystals hidden within the rock?

Déan Teagmháil
An féidir leat na críochstail níos mó atá folaithe sa charraig a aimsiú?

Description

Each of the four types of rock has an etched metal plate bolted at the base that gives details of age, how it was formed and how it feels.

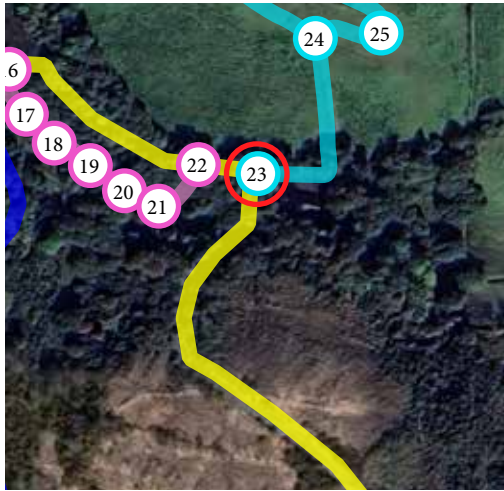

Sign Type E
Accessible Lectern Sign

Identifier Code
4-N60-001

Panel Requirements
1 x (868 x 574) panel



Position
Right of boardwalk entrance

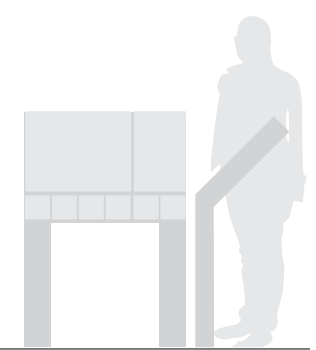
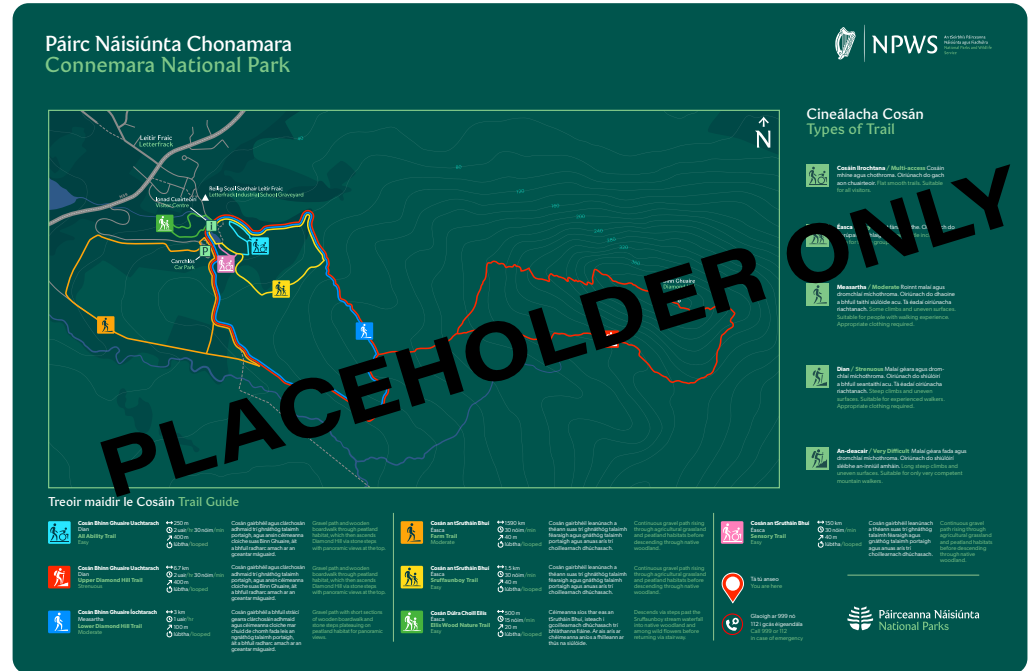

Sign Location 23

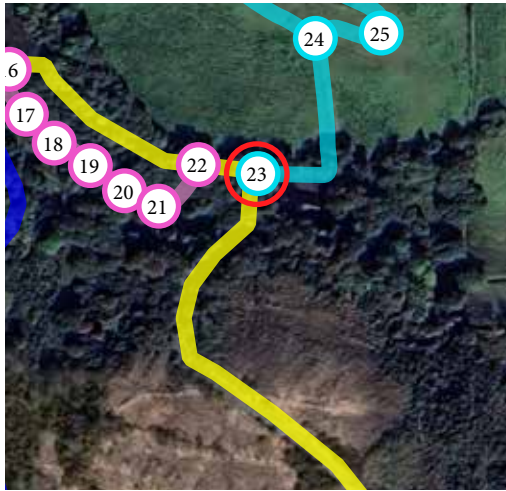

Sign Type G2
Reduced Height Large
Directional Totem

Identifier Code
4-N60-002

Panel Requirements
1 x (280 x 280) panel

Side A

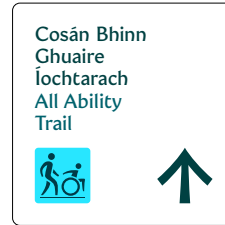

Side B

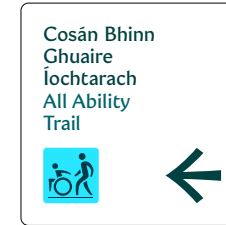

Position
Left of boardwalk entrance

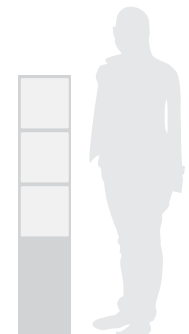
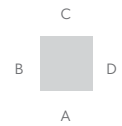

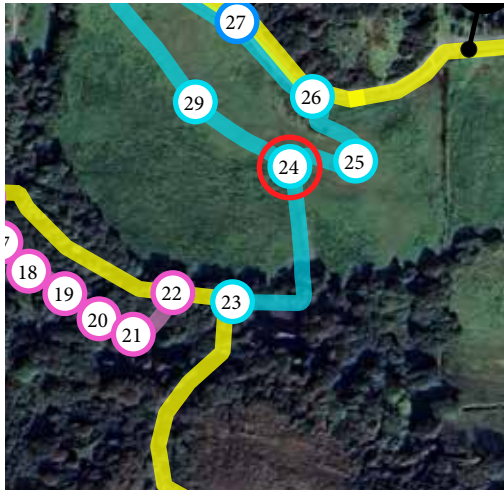

Sign Type E
Accessible Lectern Sign

Identifier Code
4-N60-003

Panel Requirements
1 x (868 x 574) panel

NOTE:
Signage is mounted on boardwalk - will need suitable mounting - The handrail can also be used to make the mounting more stable.



Position
First alcove on boardwalk



Control of invasive plant species

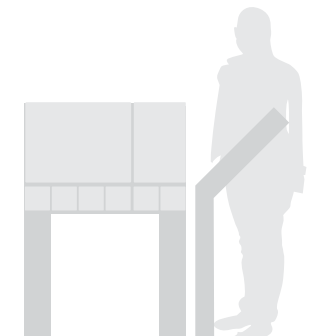

Sign Location 24

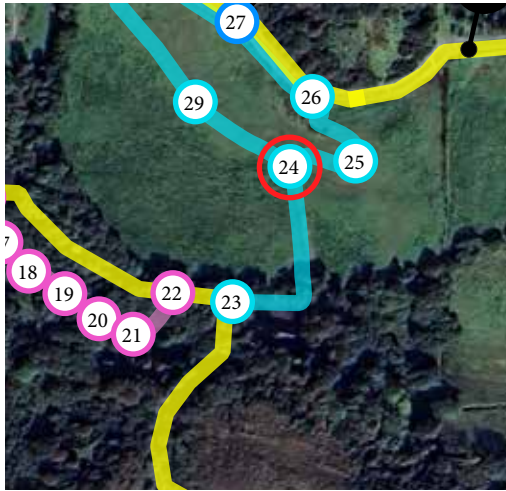

Sign Type F
Small Directional
Totem

FT_AA_Small.pdf

Identifier Code
4-N60-004

Panel Requirements
6x (133 x 133) panels

NOTE:
Signage is mounted
on boardwalk -
will need suitable
mounting - May need
to be extended to sink
into ground through
boardwalk and fix
with concrete.

Position
At t junction along boardwalk

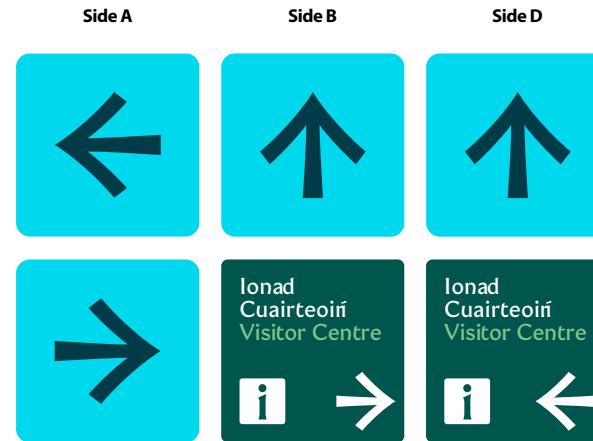

Sign Location 25

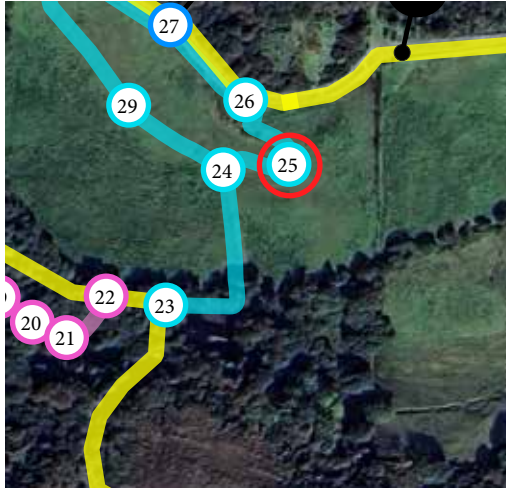

Tactile signage
Upright sign with tactile moving glacier bolder inc through boardwalk support

Identifier Code
4-N60-005

Panel Requirements
....

NOTE:
Signage is mounted on boardwalk - will need suitable mounting - May need to be extended to sink into ground through boardwalk and fix with concrete.

Position
Lookout point on boardwalk

Connemara National Park

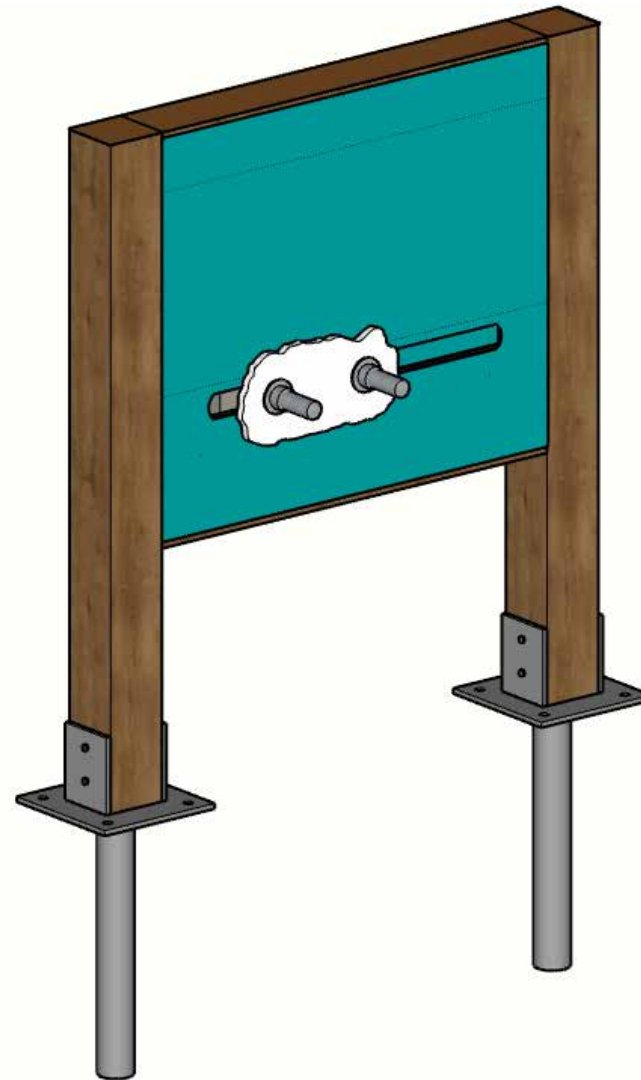

Oak framework in keeping with the style of existing signage.

Signage with faux erratic bolder/ glacier to the front. Concrete or stone material lines internal surface on the signage. User pulls the bolder across the signage which creates a grinding sound and vibration.

Experience the heavy slow moving friction that shapes valleys.

Glaciation and landscape formation

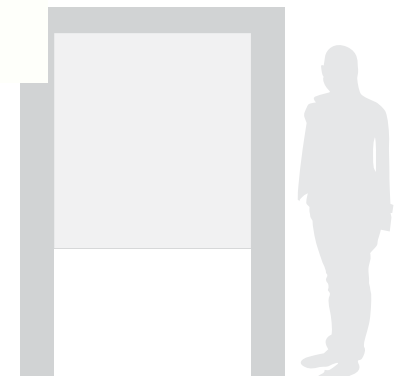

Sign Location 26



Sign Type G2
Reduced Height Large
Directional Totem

Identifier Code
4-N60-006

Panel Requirements
1 x (280 x 280) panel

Side C

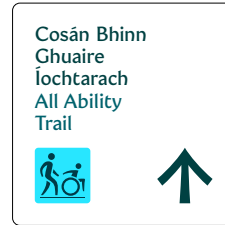

Position
At entrance to All
Ability Trail and from
Sruffaunboy Trail

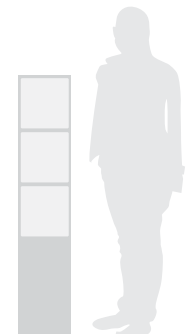
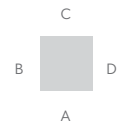

Sign Location 26



Sign Type F
Small Directional Totem

Identifier Code
4-N60-007

Panel Requirements
11x (133 x 133) panels

Notes
Replaces existing sign
Match orientation



Position
At intersection of
All Ability Trail and
Sruffaunboy Trail

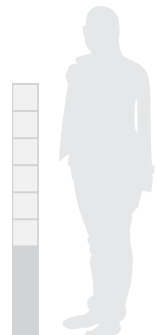
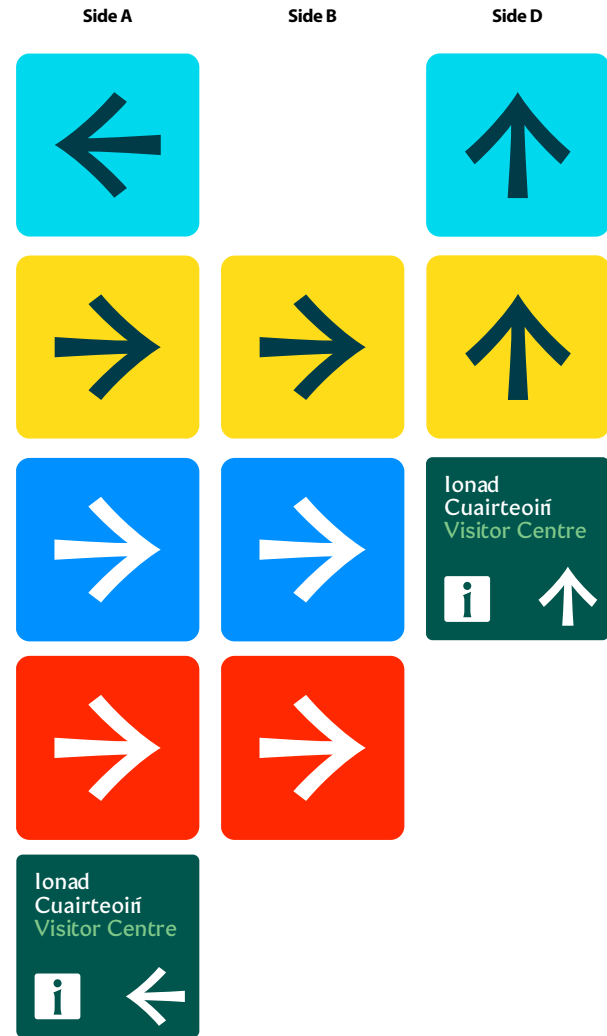

Sign Location 27 (109 on original)

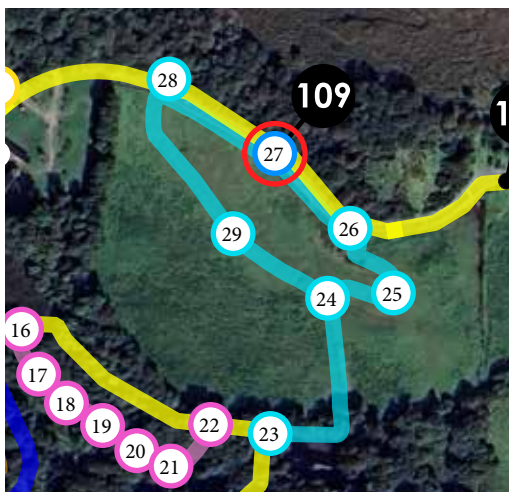

Sign Type E
Accessible Lectern Sign

Identifier Code
4-N60-008

Panel Requirements
1 x (868 x 574) panel



Position
Along Sruffaunboy Trail
between intersections
with All Ability trail

Currently where 109 on original plan is located

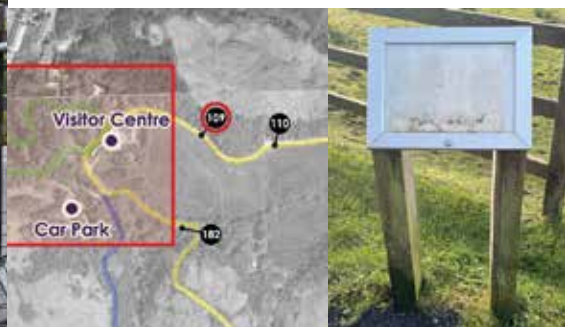

Plants on the Yellow trail
Sruffaunboy

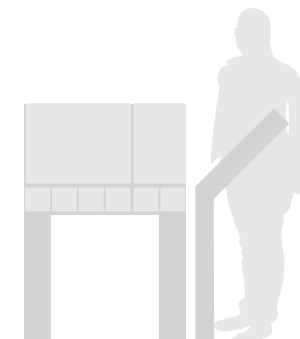

Sign Location 28

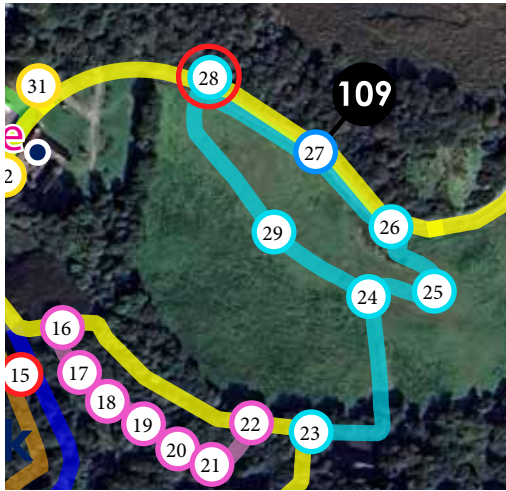

Sign Type F
Small Directional
Totem

L-GEN-100-TP-F-A1.pdf
Existing WF signage

Identifier Code
4-N60-009

Panel Requirements
8x (133 x 133) panels

Notes
Replaces existing sign
Match orientation

Position
At intersection of
All Ability Trail and
Sruffaunboy Trail

Side A

Side B

Side D

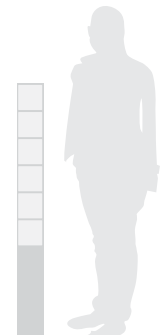

Sign Location 28

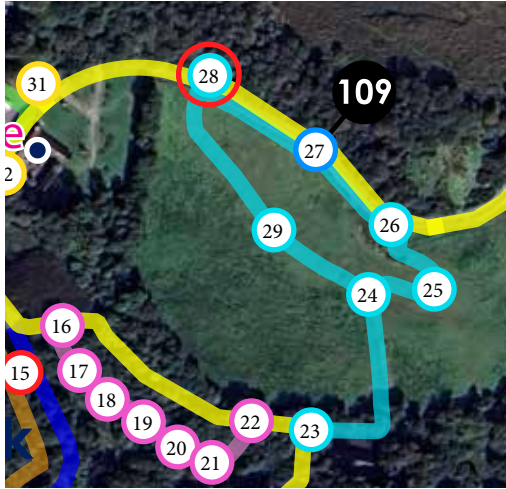

Sign Type G2
Reduced Height Large
Directional Totem

Identifier Code
4-N60-010

Panel Requirements
1 x (280 x 280) panel

Side A

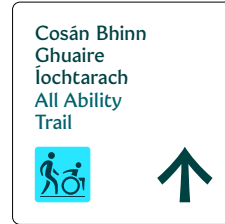

Position
At intersection of
All Ability Trail and
Sruffaunboy Trail

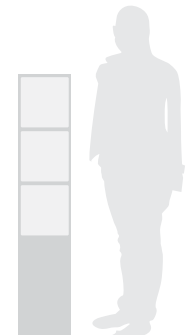
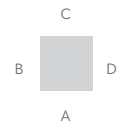

Sign Location 29

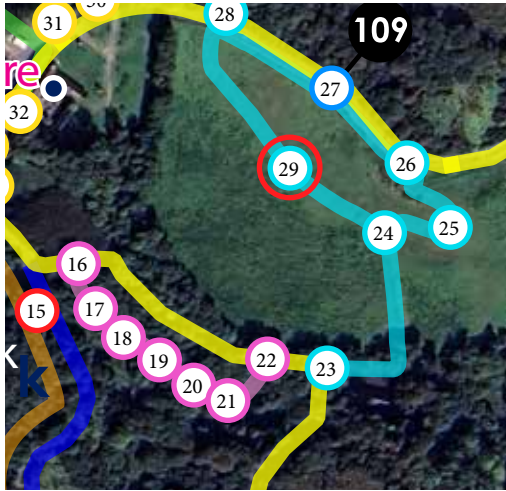

Sensory Element
Upright freechimes with sign inc through boardwalk support

Identifier Code
4-N60-011

Panel Requirements
1 x (868 x 574) panel

NOTE:
Signage is mounted on boardwalk - will need suitable mounting - May need to be extended to sink into ground through boardwalk and fix with concrete

Position
Lookout point on boardwalk

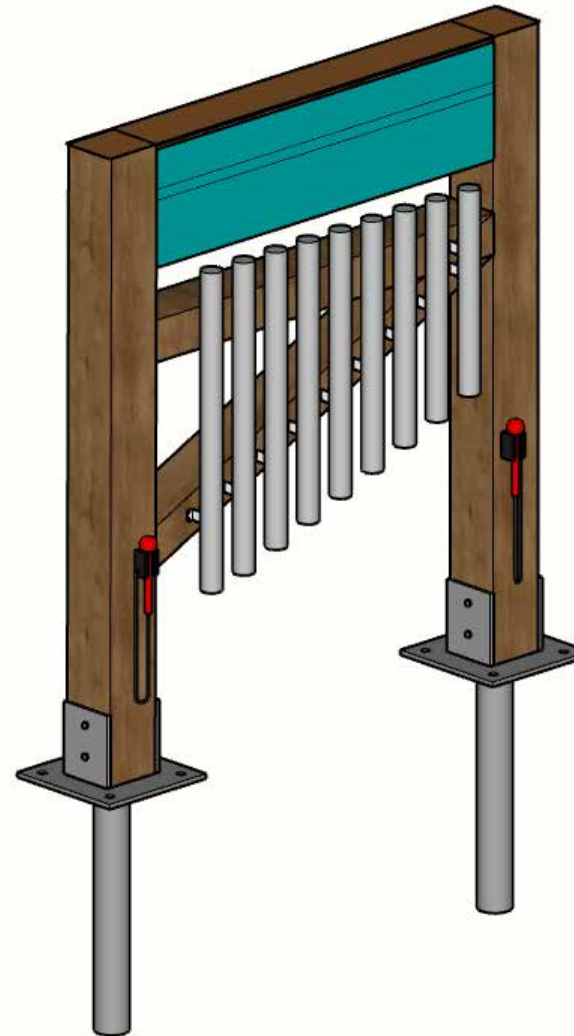

Oak framework in keeping with the style of existing signage.

8no. freechimes fixed to framework. Each chime marked by an animal/plant and tuned to notes listed on the corresponding display.

A sequence of animals/plants is displayed on the panel above which users can follow to play a familiar tune.





Sign Type E
Accessible Lectern Sign

Identifier Code
5-N60-003

Vinyl Requirements
1 x (868 x 574) panel



SAC and Habitats

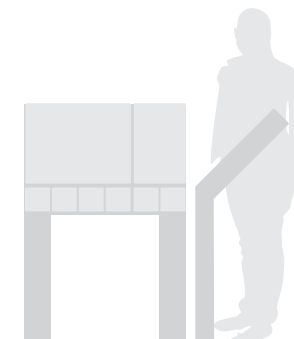

Sign Location 31



Sign Type E
Accessible Lectern Sign

Identifier Code
5-N60-004

Panel Requirements
1 x (868 x 574) panel



Position
Towards rear of Eco Enclave area

Eco Enclave

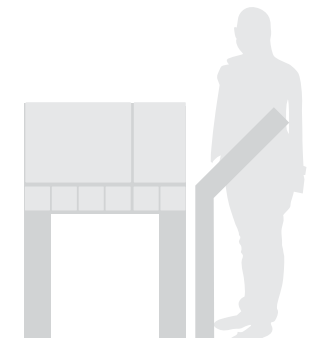

Sign Location 31

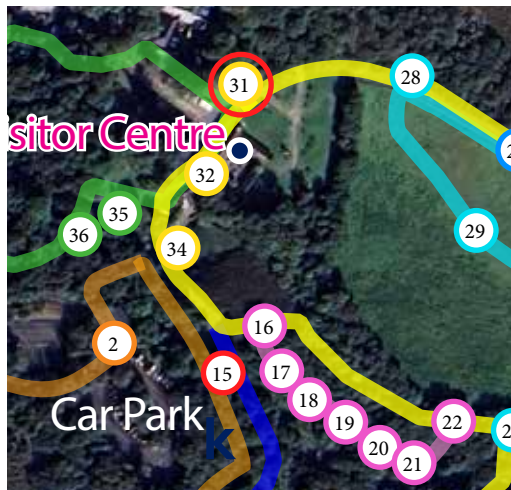

Audio Bench
Eco Enclave information

Identifier Code
5-N60-005

Panel Requirements
1 x (868 x 574) panel



Position
Towards rear of Eco Enclave area



Sign Location 32

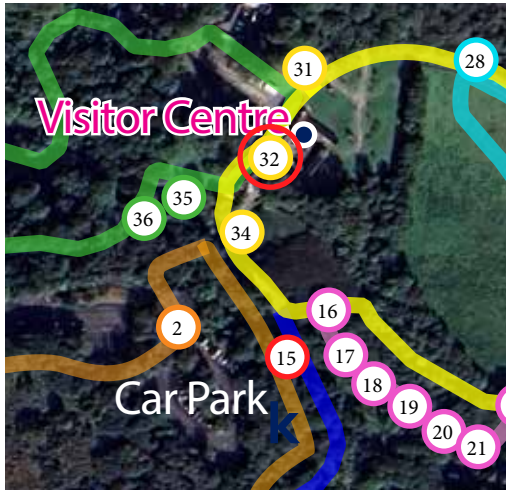

Frestanting sign
Rotating discovery disc

Identifier Code
5-N60-006

Panel Requirements
1 x (868 x 574) panel



Position
To the right of the entrance path to the visitor centre.

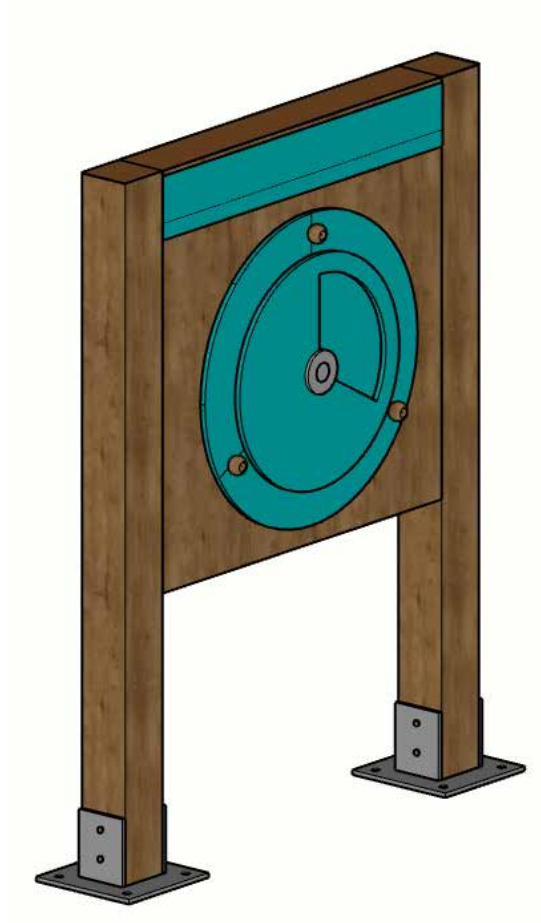

Oak framework in keeping with the style of existing signage.

20mm thick, 800mm dia. internal rotatable HDPE disc or similar.

600mm dia. fixed external disc

3no. graphic divisions - Before buildings, first buildings, today.

Users turn the disc to reveal information about pollinating insects.

Changing landscape





Sign Type E
Accessible Lectern Sign

Identifier Code
5-N60-007

Panel Requirements
1 x (868 x 574) panel



.....
Cows and Sheep
Potential Accessible Lectern Sign
here

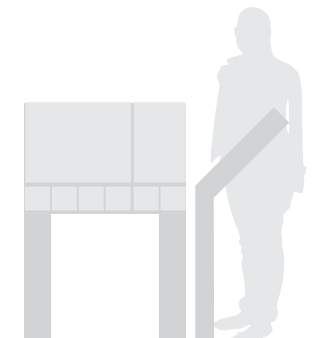

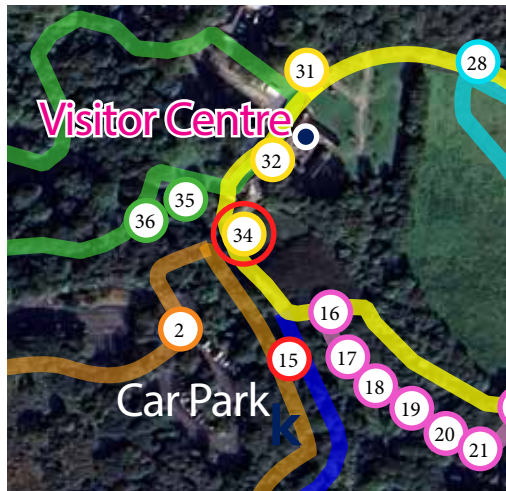

Sign Type E
Accessible Lectern Sign

Identifier Code
5-N60-008

Panel Requirements
1 x (868 x 574) panel



Beekeepers Association

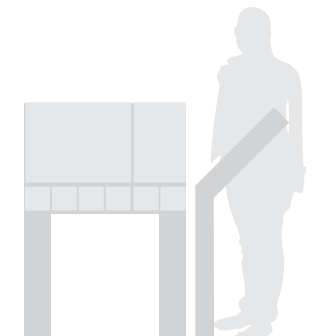

Sign Location 35

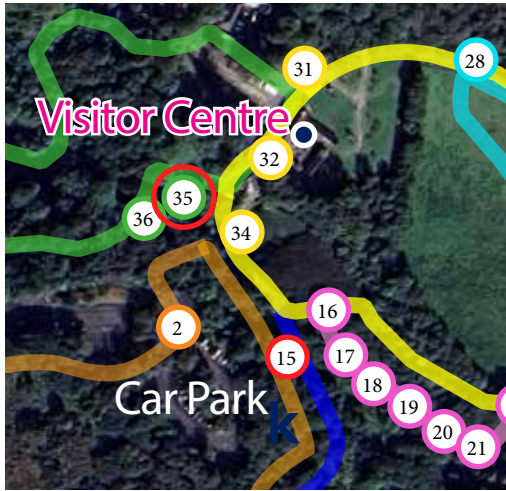

Tactile sign
Upright olfactory display
inc 4 lift-and-sniff flaps wit
concrete pad + signage

Identifier Code
6-N60-001

Panel Requirements
1 x (868 x 574) panel

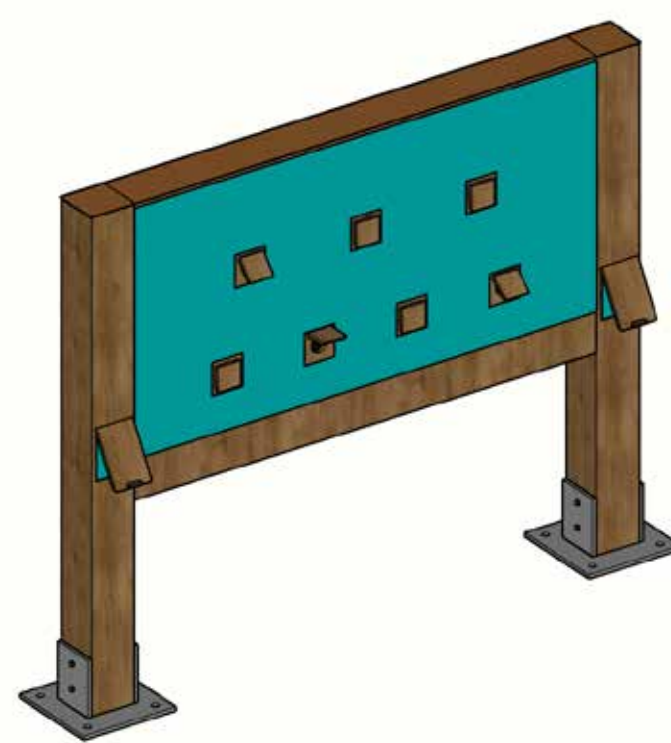

Oak framework in keeping with the style of existing signage.

7 no. perforated aroma boxes with lift up flaps.

User sniff the boxes to guess the smells of the forest.

Use the lift up flaps to see the correct answers.



Position
To the right of the entrance
path to the visitor centre.

Aromas of the Wood



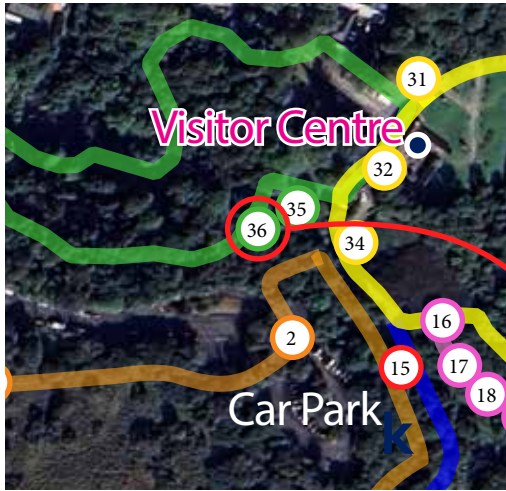

Sign Type E
Accessible Lectern Sign

Identifier Code
6-N60-002

Panel Requirements
1 x (868 x 574) panel

NOTE: Now moved



Hydro Room



Position
AT INTAKE



Sign Location 37



Tactile sign

Upright frame inc 4x rotating tree sections and lift up answer flap

Identifier Code

6-N60-001

Panel Requirements

1 x (868 x 574) panel

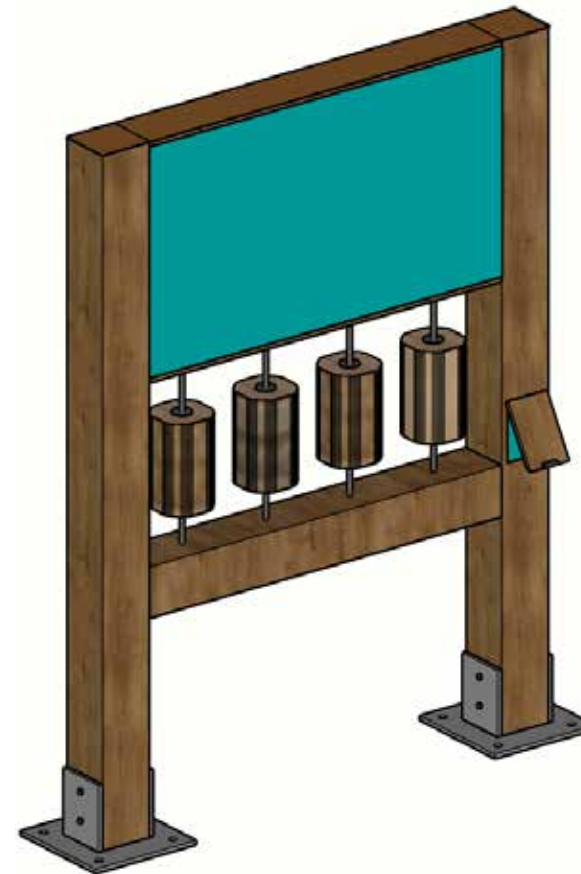

Guess the Tree Age

Oak framework in keeping with the style of existing signage.

4 no. tree cross sections, e.g. Downy Birch, Rowan, Sessile Oak, Scots Pine

Turn the tree cross sections to line up the numbers (age) of each tree to the front.

Use the lift up flap to see the correct answers.



Bus stop and pedestrian entrance

Connemara National Park



Bus stop and pedestrian entrance

1. **Welcome Sign (Extended legs)**
1no. Welcome Panel (1190 x 1350)
2. **WF Reduced Height Large Directional Totem (Modified)**
4no. National Park, Visitor Centre Panels (280 x 280)
3. **Road Signage**
1no. National Park (1250 x 500)
4. **WF Reduced Height Large Directional Totem (Modified)**
4no. National Park, Visitor Centre Panels (280 x 280)
5. **WF Reduced Height Large Directional Totem (Modified)**
4no. National Park, Visitor Centre Panels (280 x 280)
6. **Wall mounted sign**
1no. National Park, Visitor Centre Panels (1000 x 350)
7. **Carpark & Directional Information Sign**
1no. No Unauthorised Vehicles Panel (574 x 574)
2no. National Park, Visitor Centre (133 x 133)
8. **Carpark & Directional Information Sign (Panels Only)**
2no. National Park, Visitor Centre (133 x 133)

QUANTITIES

- 1no. **Welcome Sign Modified** (*Sign Type A1*)
- 3no. **Reduced Height Large Directional Totem (Some Modified)**
(*Sign Type G2*)
- 1no. **Carpark & Directional Information Sign** (*Sign Type C*)
- 1no. **Road Sign with rails and collars (1250 x 500)** (*Road sign*)
- 1no. **Wall Mounted Sign (Approx 1000 x 350)** (*Road sign*)
- 1no. **Panel (1190 x 1350)**
- 12no. **Panels (280 x 280)** (*Large Square Panel*)
- 1no. **Panels (1250 x 500)**
- 1no. **Panels (574 x 574)**
- 4no. **Panels (133 x 133)** (*Small Square Panel*)

Sign Location (Bus and Pedestrian) 01

Sign Type A1
Welcome Sign extended legs

Identifier Code
7-N60-001

Panel Requirements
1 x (1190 x 1350) panel

Notes
Extended legs to accommodate 900mm wall

Position
Mounted on pad behind wall



Query
Is this considered Multi Access (wheelchair friendly) or just Easy?

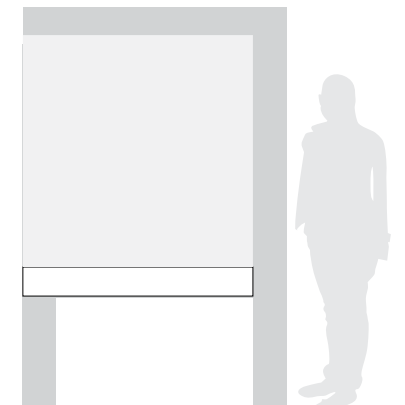

Sign Type G2
Reduced Height Large
Directional Totem

Identifier Code
7-N60-002

Panel Requirements
4 x (280 x 280) panel

Notes
Type G2 totem reduced
height and side mounted
wall bracket.

Distances to be added to
each sign

Position
Mounted to internal side
of wall with bracket



Side A



Side B



Query
Is this considered Multi Access (wheelchair friendly) or just Easy?

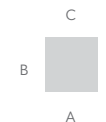

Sign Type

Metal road signage with rails and post collars

Identifier Code

7-N60-003

Panel Requirements

1 x (1250 x 500) panel

Notes

Metal roadsige with rails and post collars mounted onto existing posts

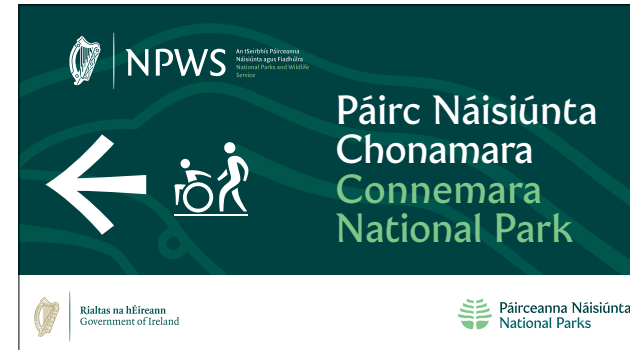
**Query**

Is this considered Multi Access (wheelchair friendly) or just Easy?

**Position**

Onto existing sign



Sign Type G2
Reduced Height Large
Directional Totem

Identifier Code
7-N60-004

Panel Requirements
4 x (280 x 280) panel

Notes
Type G2 totem reduced
height and side mounted
wall bracket.

Distances to be added to
each sign

Position
Mounted to internal side
of wall with bracket



Side A



Side B



Query
Is this considered Multi Access (wheelchair friendly) or just Easy?

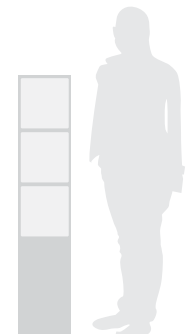
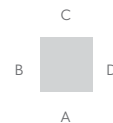

Sign Type G2
Reduced Height Large
Directional Totem

Identifier Code
7-N60-005

Panel Requirements
4 x (280 x 280) panel

Notes
Type G2 totem reduced
height and side mounted
wall bracket.

Distances to be added to
each sign

Position
Mounted to internal side
of wall with bracket



Side A



Side B



Query
Is this considered Multi Access (wheelchair friendly) or just Easy?

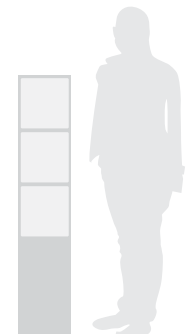
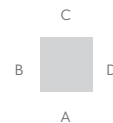

Sign Type
Metal road signage
mounted directly to wall

Identifier Code
7-N60-006

Panel Requirements
1 x (1000x 350) panel

Notes
...

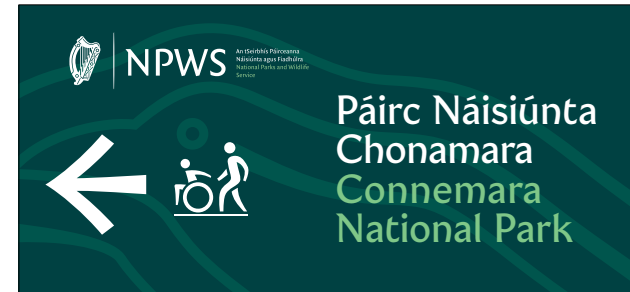

Query
Is this considered Multi Access (wheelchair friendly) or just Easy?



Position
Mounted on wall



Sign Type C

Car Park Directional & Information Sign

Identifier Code

7-N60-007

Panel Requirements

1 x (574 x 574) panel
2 x (133 x 133) panel

Notes

Replaces existing signs



L-GEN-160-VH-C-A1.pdf



Position

Mounted on wall

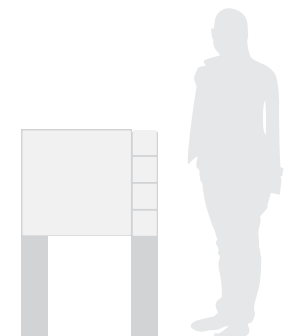

Sign Type C

Car Park Directional & Information Sign (Panels only)

Identifier Code

7-N60-008

Panel Requirements

2 x (133 x 133) panel

Notes

Small panels only

Position

Mounted onto existing signage



Existing WF

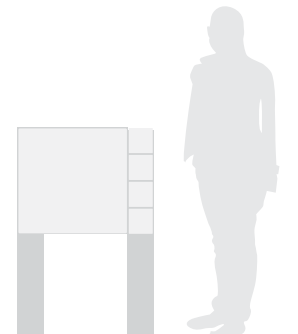

Amended/additional panels/Vinyl for existing frames

Connemara National Park



Amended/additional panels/Vinyl for existing frames

1. **(102) WF Reduced Height Large Directional Totem**
2no. All Ability, Sensory Trail Panel (280 x 280)
2. **(108) Accessible Lectern Sign**
1no. Map (Vinyl Only) (868 x 574)
3. **(111) Accessible Lectern Sign**
1no. Map (Vinyl Only) (868 x 574)
4. **(118) Accessible Lectern Sign**
1no. Map (Vinyl Only) (868 x 574)
5. **(119) Accessible Lectern Sign**
1no. Map (Vinyl Only) (868 x 574)
6. **(121) Accessible Lectern Sign**
1no. Map (Vinyl Only) (868 x 574)
7. **(125) Accessible Lectern Sign**
1no. Map (Vinyl Only) (868 x 427)
2no. Blue Arrow, Red Arrow Panel (133 x 133)
8. **(126) WF Small Directional Totem**
2no. Farm Trail Arrow Panel (133 x 133)
9. **(127) WF Small Directional Totem**
1no. Map (Vinyl Only) (868 x 574)
10. **(135) WF Reduced Height Large Directional Totem**
1no. Farm Trail Title Panel (280 x 280)
11. **(143) Info and Directional Totem**
1no. Map (Vinyl only) (868x868)
1no. Welcome panel (1162x574)

QUANTITIES

- | | |
|------|--|
| 6no. | Vinyl Rewrap Only (868 x 574) |
| 1no. | Vinyl Rewrap Only (868 x 427) |
| 1no. | Vinyl Rewrap Only (868x868) |
| 4no. | Panels (133 x 133) (<i>Small Square Panel</i>) |
| 3no. | Panel (280 x 280) (<i>Large Square Panel</i>) |
| 1no. | Panel (1162x574) |

Sign Location 1 (102)

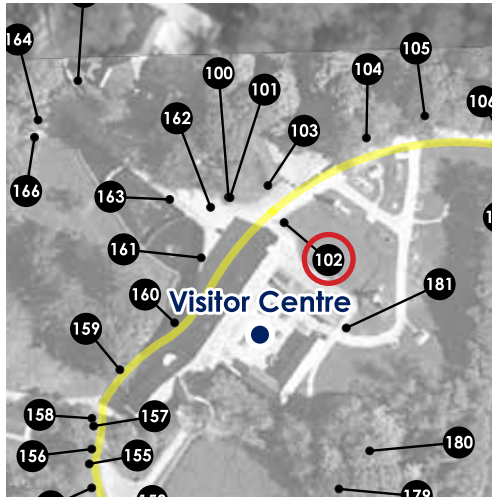

Sign Type G1
Large Directional Totem

Identifier Code
8-N60-001

Panel Requirements
2x (280 x 280) panel

Notes
Steel plaques with All Ability and Sensory trails title and arrow

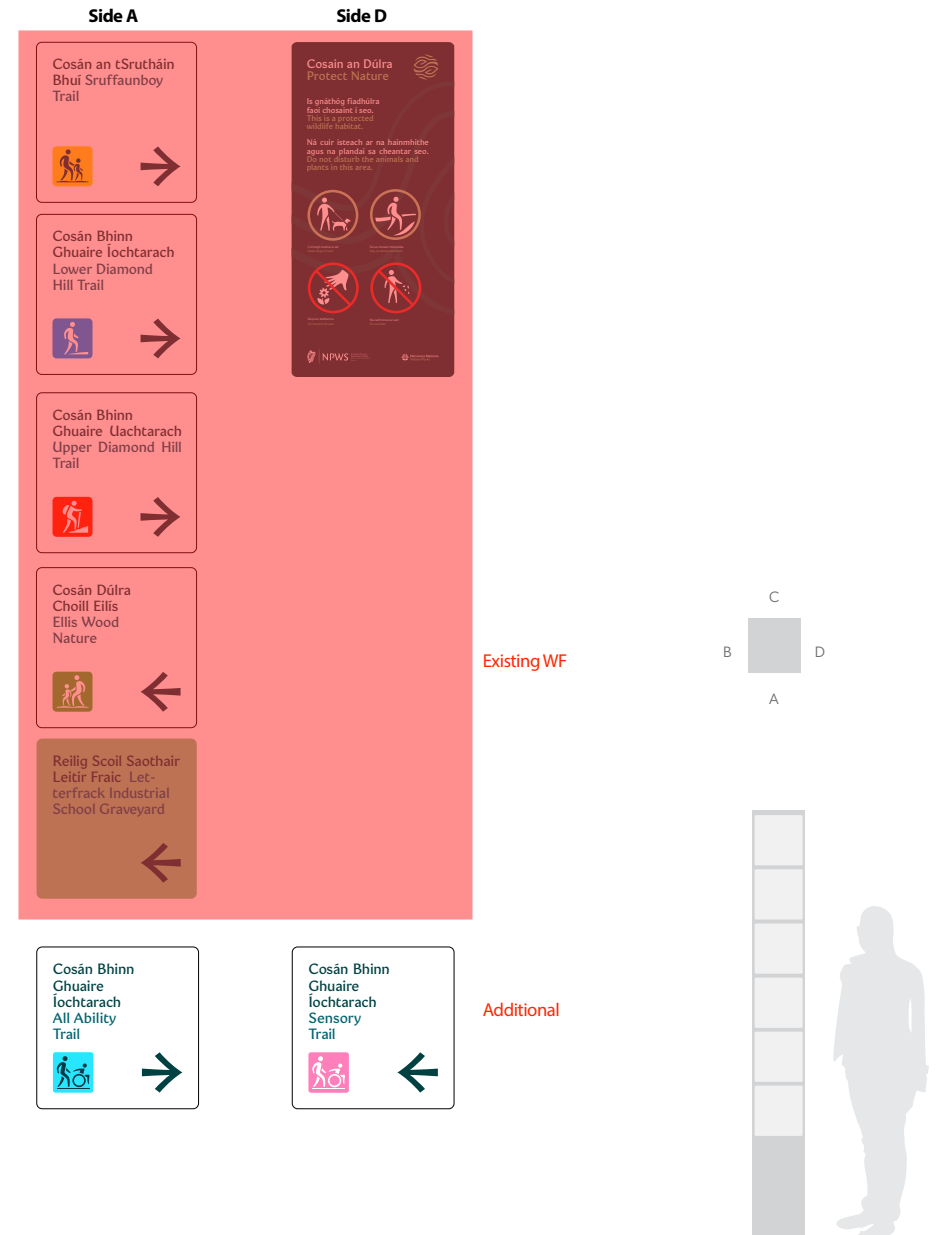

Sign Location 2 (108)

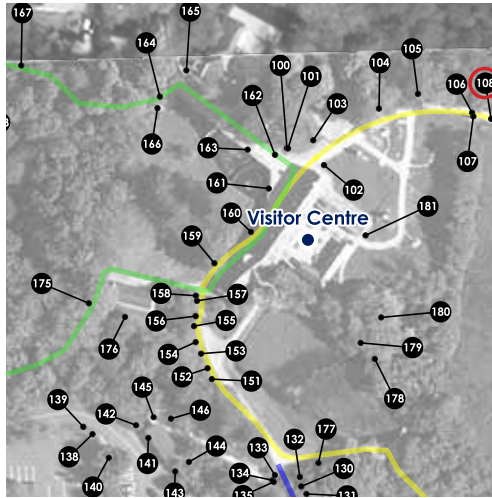

Sign Type E
Accessible Lectern Sign

Identifier Code
8-N60-002

Vinyl Requirements
1 x (868 x 574) Vinyl only



Notes
Vinyl rewrap Only

Páirc Náisiúnta Chonamara
Connemara National Park

Cineálacha Cosáin
Types of Trail

- Cosáin Beathacha / Health routes** Cosáin níos sine agus níos airde agus chothroma. Chomáirle do gach aois agus leibhéal. Níl aon teorainn. Suidh ar fáil do lucht siar.
- Easca / Easy Routes** Cosáin níos ísle. Chomáirle do dhaoine a bhfuil tairne acu. Tá fáil ar chomáirle do dhaoine a bhfuil tairne acu. Suidh ar fáil do lucht siar.
- Masairthe / Mountain Routes** Cosáin níos airde agus níos airde. Chomáirle do dhaoine a bhfuil tairne acu. Tá fáil ar chomáirle do dhaoine a bhfuil tairne acu. Suidh ar fáil do lucht siar.
- Dian / Strenuous** Cosáin níos airde agus níos airde. Chomáirle do dhaoine a bhfuil tairne acu. Tá fáil ar chomáirle do dhaoine a bhfuil tairne acu. Suidh ar fáil do lucht siar.
- An-déanach / Very Difficult** Cosáin níos airde agus níos airde. Chomáirle do dhaoine a bhfuil tairne acu. Tá fáil ar chomáirle do dhaoine a bhfuil tairne acu. Suidh ar fáil do lucht siar.

Treoir maidir le Cosáin Trail Guide

Cosáin Beathacha Health Routes	• 200m • 400m • 600m • 800m • 1000m	Cosáin gairbhál agus chothroma a bhfuil tairne acu do dhaoine a bhfuil tairne acu. Tá fáil ar chomáirle do dhaoine a bhfuil tairne acu. Suidh ar fáil do lucht siar.	Cosáin gairbhál agus chothroma a bhfuil tairne acu do dhaoine a bhfuil tairne acu. Tá fáil ar chomáirle do dhaoine a bhfuil tairne acu. Suidh ar fáil do lucht siar.	Cosáin ar Ghruaig Rocky Trails	• 100m • 200m • 300m • 400m • 500m	Cosáin gairbhál agus chothroma a bhfuil tairne acu do dhaoine a bhfuil tairne acu. Tá fáil ar chomáirle do dhaoine a bhfuil tairne acu. Suidh ar fáil do lucht siar.	Cosáin gairbhál agus chothroma a bhfuil tairne acu do dhaoine a bhfuil tairne acu. Tá fáil ar chomáirle do dhaoine a bhfuil tairne acu. Suidh ar fáil do lucht siar.	Cosáin ar Ghruaig Rocky Trails	• 100m • 200m • 300m • 400m • 500m	Cosáin gairbhál agus chothroma a bhfuil tairne acu do dhaoine a bhfuil tairne acu. Tá fáil ar chomáirle do dhaoine a bhfuil tairne acu. Suidh ar fáil do lucht siar.	Cosáin gairbhál agus chothroma a bhfuil tairne acu do dhaoine a bhfuil tairne acu. Tá fáil ar chomáirle do dhaoine a bhfuil tairne acu. Suidh ar fáil do lucht siar.	Cosáin ar Ghruaig Rocky Trails	• 100m • 200m • 300m • 400m • 500m	Cosáin gairbhál agus chothroma a bhfuil tairne acu do dhaoine a bhfuil tairne acu. Tá fáil ar chomáirle do dhaoine a bhfuil tairne acu. Suidh ar fáil do lucht siar.	Cosáin gairbhál agus chothroma a bhfuil tairne acu do dhaoine a bhfuil tairne acu. Tá fáil ar chomáirle do dhaoine a bhfuil tairne acu. Suidh ar fáil do lucht siar.
--	---	--	--	--	--	--	--	--	--	--	--	--	--	--	--

Change or 955 05
192 gairbhál
Call 955 05 192
www.npws.gov.ie

Páirc Náisiúnta
National Parks

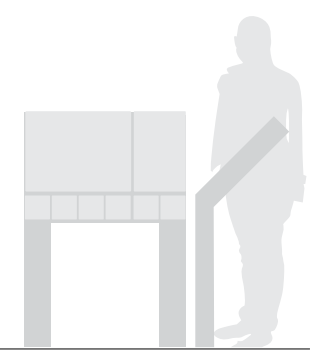

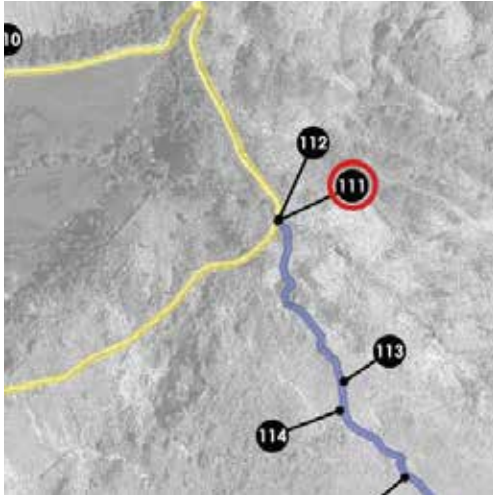

Sign Type E
Accessible Lectern Sign

Identifier Code
8-N60-003

Vinyl Requirements
1 x (868 x 574) Vinyl only

Notes
Vinyl rewrap Only



Páirc Náisiúnta Chonamara Connemara National Park

National Parks and Wildlife Service
Seirbhís Náisiúnta Árainne agus Éiceolaíochta

Cineálacha Cosán Types of Trail

- Cosán Breitheanna** / Family access Cosán náisiúnta aige chloítheanna. Chloítheach do gach aois chomhathúil. Tair amach trátha, bairneacha, foras na h-uisce.
- Easca** / Easy Rosánt fáil réidhe. Chloítheach do ghluaise treaghacha, fáil réidhe arís. Tair amach trátha, bairneacha, foras na h-uisce.
- Measúrtha** / Measúrtha Rosánt meáil aige do mhóir mhóirtheanna. Chloítheach do dhaoine a bhfuil fáil réidhe acu. Tá fáil ar chloítheach na h-ádh. Tair amach trátha, bairneacha, foras na h-uisce. Tair amach trátha, bairneacha, foras na h-uisce.
- Díon** / Streoimne Meáil gearra aige do mhóir mhóirtheanna. Chloítheach do dhaoine a bhfuil fáil réidhe acu. Tá fáil ar chloítheach na h-ádh. Tair amach trátha, bairneacha, foras na h-uisce. Tair amach trátha, bairneacha, foras na h-uisce.
- An-déiseal** / Veirí Dífúil Mhór gheara fáil réidhe ar mhóir mhóirtheanna. Chloítheach do dhaoine a bhfuil fáil réidhe acu. Tá fáil ar chloítheach na h-ádh. Tair amach trátha, bairneacha, foras na h-uisce. Tair amach trátha, bairneacha, foras na h-uisce.

Treoir maidir le Cosán Trail Guide

<p> Cosán Breitheanna / Family Access Trail</p> <p>• 200m • 100m • 50m</p> <p>• 10m • 5m • 2m</p>	<p> Cosán Breitheanna / Family Access Trail</p> <p>• 200m • 100m • 50m</p> <p>• 10m • 5m • 2m</p>	<p> Cosán Breitheanna / Family Access Trail</p> <p>• 200m • 100m • 50m</p> <p>• 10m • 5m • 2m</p>	<p> Cosán Breitheanna / Family Access Trail</p> <p>• 200m • 100m • 50m</p> <p>• 10m • 5m • 2m</p>
--	--	--	--

Change or 999 (06 912) gairneoraí
Call 999 or 112 in case of an emergency

Páirc Náisiúnta National Parks

Sign Location 4 (118)

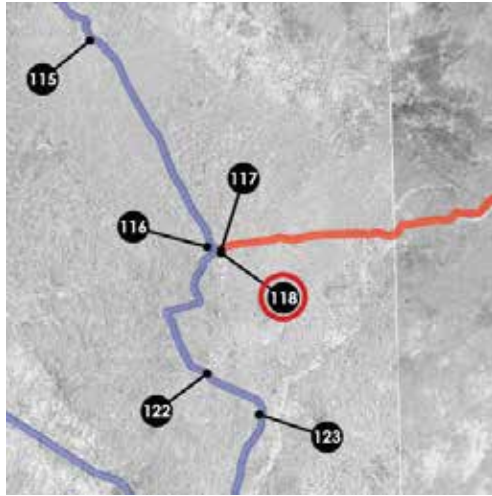

Sign Type E
Accessible Lectern Sign

Identifier Code
8-N60-004

Vinyl Requirements
1 x (868 x 574) Vinyl only



Notes
Vinyl rewrap Only

Páirc Náisiúnta Chonamara
Connemara National Park

Cineálacha Cosán
Types of Trail

- Cosán Breacchra** / Multi-access Cosán: Inléig agus chloítheora. Chloítheora do gach an chosánach. Níl aonach leath, b'fhéidir do dhiaibh.
- Easca** / Easy: Rosáil ísle nó ísle. Chloítheora do dhiaibh leathbhá. Cosán gearr, fáil ar fáil.
- Mearshra** / Mairbhra: Rosáil meáil agus ísle nó ísle. Chloítheora do dhiaibh leathbhá. Níl aonach leath, b'fhéidir do dhiaibh leathbhá. Fáil ar fáil.
- Dian** / Streanna: Mairbhra gearr agus ísle nó ísle. Chloítheora do dhiaibh leathbhá. Níl aonach leath, b'fhéidir do dhiaibh leathbhá. Fáil ar fáil.
- An-dian** / Viny Difficult: Mairbhra fáil agus ísle nó ísle. Chloítheora do dhiaibh leathbhá. Níl aonach leath, b'fhéidir do dhiaibh leathbhá. Fáil ar fáil.

Treoir maidir le Cosán Trail Guide

Cosán Breacchra Multi-access Cosán	Cosán Breacchra Multi-access Cosán	Cosán Breacchra Multi-access Cosán	Cosán Breacchra Multi-access Cosán
Cosán Breacchra Multi-access Cosán	Cosán Breacchra Multi-access Cosán	Cosán Breacchra Multi-access Cosán	Cosán Breacchra Multi-access Cosán

Connemara National Park
Páirc Náisiúnta Chonamara

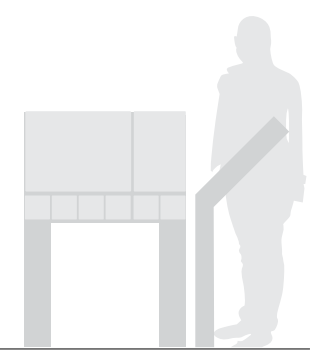

Sign Location 5 (119)

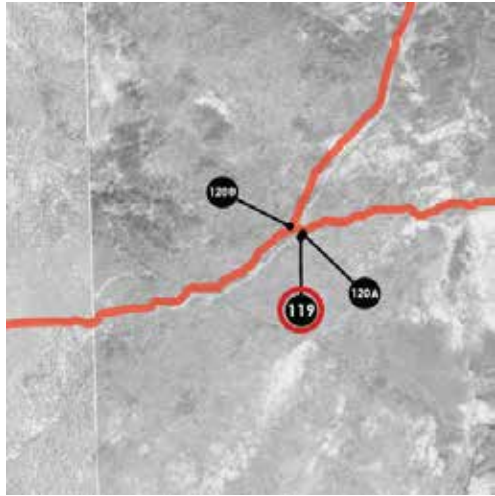

Sign Type E
Accessible Lectern Sign

Identifier Code
8-N60-005

Vinyl Requirements
1 x (868 x 574) Vinyl only



Notes
Vinyl rewrap Only

Páirc Náisiúnta Chonamara
Connemara National Park

Cineálacha Cosán
Types of Trail

- Cosán Breathna** / **Trail** **Breathna** **Trail**
Máil náisiúnta Cosán náisiúnta a chloíonn, Oileánach do gach an t-athair. **Trail** náisiúnta, **Trail** náisiúnta, **Trail** náisiúnta.
- Easca** / **Easy** **Easy** **Trail**
Cosán Breathna, **Trail** náisiúnta, **Trail** náisiúnta, **Trail** náisiúnta.
- Masarra** / **Medium** **Trail**
Cosán Breathna, **Trail** náisiúnta, **Trail** náisiúnta, **Trail** náisiúnta.
- Dian** / **Strenuous** **Trail**
Cosán Breathna, **Trail** náisiúnta, **Trail** náisiúnta, **Trail** náisiúnta.
- An-déan** / **Very Difficult** **Trail**
Cosán Breathna, **Trail** náisiúnta, **Trail** náisiúnta, **Trail** náisiúnta.

Treoir maidir le Cosán Trail Guide

Cosán Breathna Trail Trail	200m 300m 400m 500m	Cosán Breathna náisiúnta a chloíonn, Oileánach do gach an t-athair. Trail náisiúnta, Trail náisiúnta, Trail náisiúnta.	Cosán Breathna náisiúnta a chloíonn, Oileánach do gach an t-athair. Trail náisiúnta, Trail náisiúnta, Trail náisiúnta.	Cosán Breathna Trail Trail	1000m 1500m 2000m 2500m	Cosán Breathna náisiúnta a chloíonn, Oileánach do gach an t-athair. Trail náisiúnta, Trail náisiúnta, Trail náisiúnta.	Cosán Breathna náisiúnta a chloíonn, Oileánach do gach an t-athair. Trail náisiúnta, Trail náisiúnta, Trail náisiúnta.	Cosán Breathna Trail Trail	1000m 1500m 2000m 2500m	Cosán Breathna náisiúnta a chloíonn, Oileánach do gach an t-athair. Trail náisiúnta, Trail náisiúnta, Trail náisiúnta.	Cosán Breathna náisiúnta a chloíonn, Oileánach do gach an t-athair. Trail náisiúnta, Trail náisiúnta, Trail náisiúnta.
---	------------------------------	---	---	---	----------------------------------	---	---	---	----------------------------------	---	---

Connemara National Park
NPWS

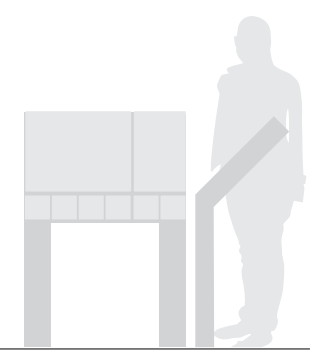

Sign Location 7 (125)

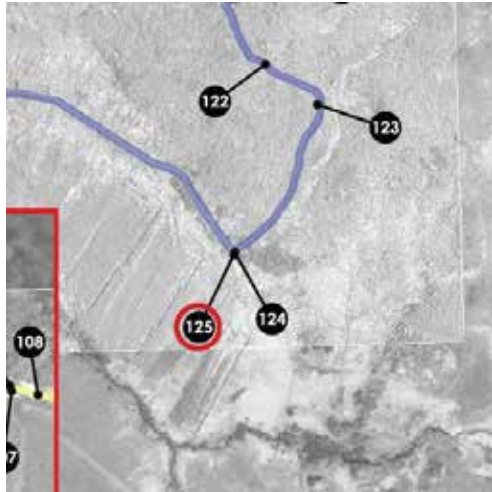

Sign Type E
Accessible Lectern Sign

Identifier Code
8-N60-007

Vinyl Requirements
1 x (868 x 427) panel
2x (133 x 133) panels
(additional upper diamond and VC plaques)

Notes
Vinyl rewrap Only (Map)
2no New plaques

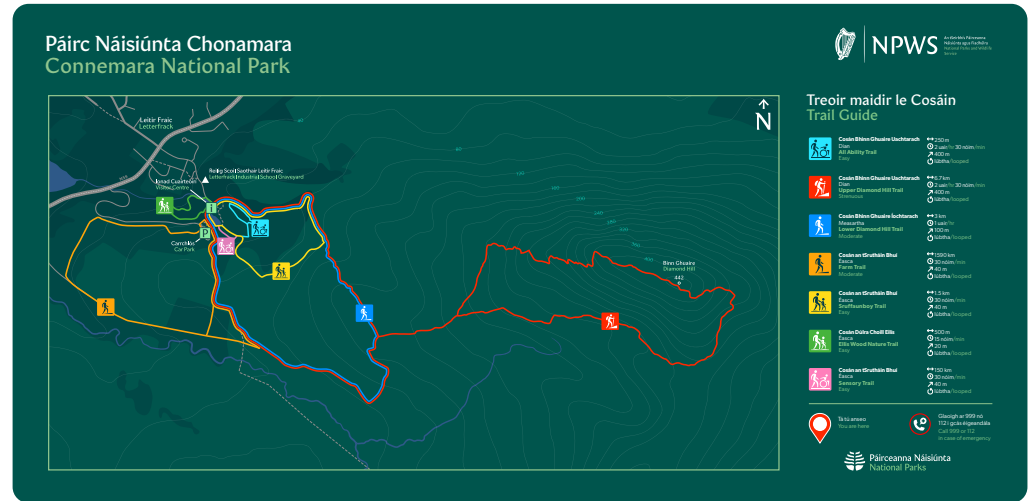

Existing WF

Map_SML_LD_04

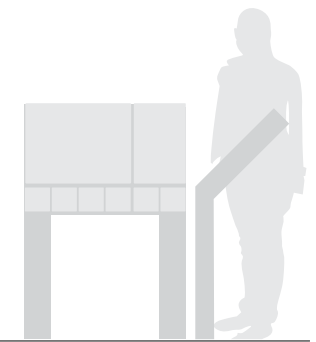

Sign Location 8 (127)

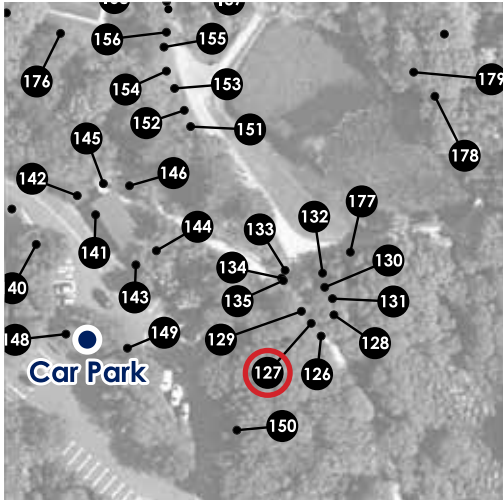

Sign Type F

Existing Small Directional Totem

Identifier Code

8-N60-008

Panel Requirements

2 x (133 x 133) panels

Notes

2 x new plaques with farm trail arrows (127 in previous report)

Position

Existing Totem

Side A

Side C

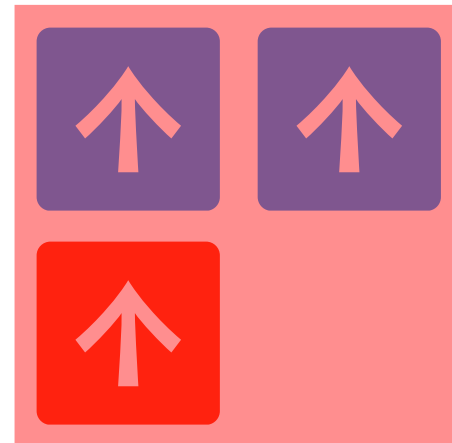

FT_WF_Small.pdf

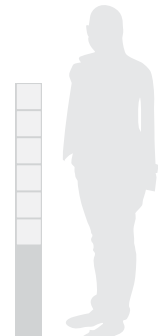

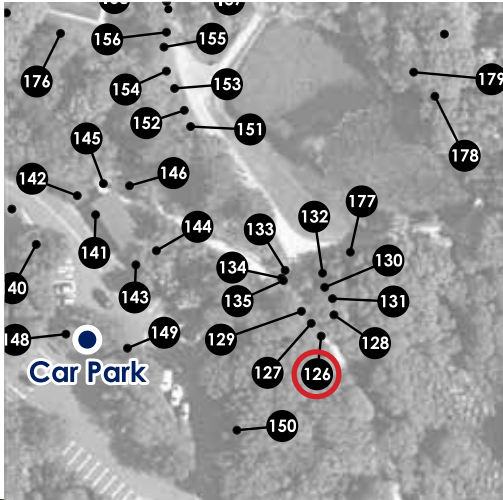

Sign Type F
Existing Small Accessible
Lectern Sign

Identifier Code
8-N60-009

Panel Requirements
1 x (868 x 574) Vinyl only

Notes
Vinyl rewrap Only
(126 in previous report)



Position
Existing Accessible
Lectern Sign



Map_LRG_FT_03.pdf

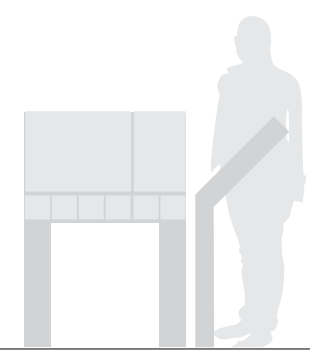

Sign Location 10 (135)

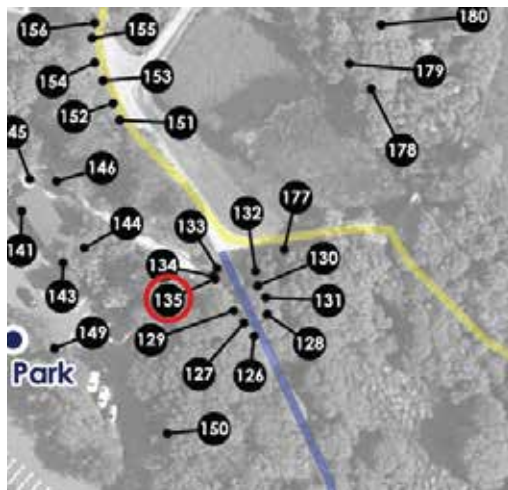

Sign Type G2
Existing Reduced Height
Large Directional Totem

Identifier Code
8-N60-010

Panel Requirements
1 x (280 x 280) panel

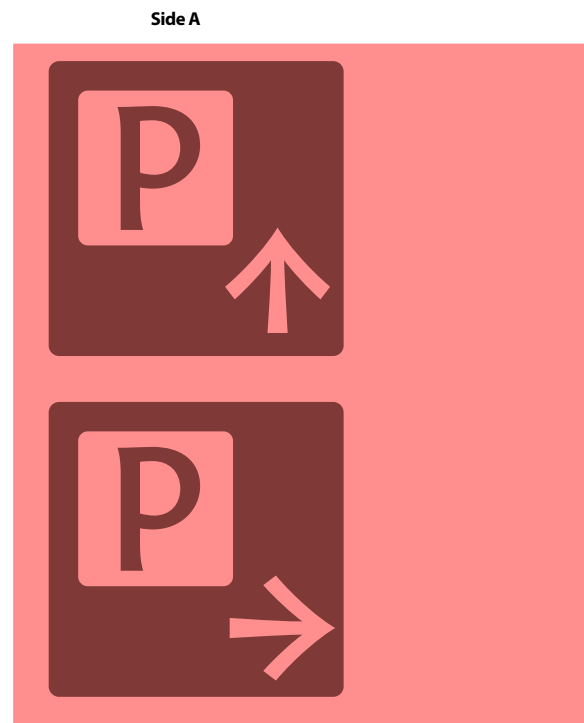

Existing WF



Additional



Sign Location 11 (143)

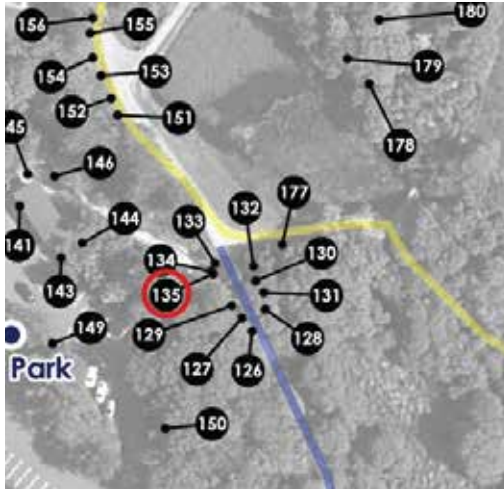

Sign Type D
Info & Direction Totem

Identifier Code
8-N60-011

Panel Requirements
1 x (1162 x 574) panel
1 x (868 x 868) vinyl only

Notes
Image of existing signage
look more like Sign Type A2
- Please confirm

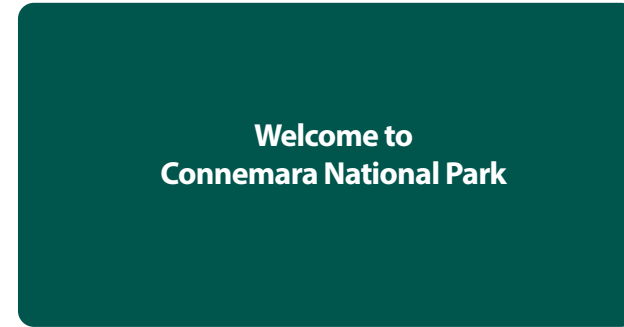

Additional Panel



Replace (Vinyl only)

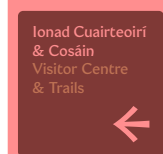

Existing WF

